

---

**Residential and Light Commercial  
Ductless Systems Catalog**

May 2022





## Table of Contents

<b>What Is Ductless Technology</b>	<b>3</b>
<b>Benefits &amp; Features</b>	<b>5</b>
<b>Heil Ductless Unit Types</b>	<b>7</b>
<b>Single Zone Residential</b>	<b>11</b>
Deluxe Series	<b>13</b>
QuietComfort® Series	<b>19</b>
Performance Series	<b>33</b>
<b>Multi-Zone</b>	<b>43</b>
<b>Single Zone Light Commercial</b>	<b>49</b>
<b>Accessories and Additional Information</b>	<b>65</b>
<b>Tiers, Warranties &amp; Controls</b>	<b>74</b>
<b>Glossary</b>	<b>75</b>



# THE DIFFERENCE BETWEEN HOT, COLD & COMFORTABLE

Ductless, also called a mini-split, is an extraordinary HVAC system that makes any room comfortable at the push of a button. It's free from long, expansive ductwork. Instead, ductless circulates conditioned refrigerant between an indoor unit and an outdoor unit connected by copper refrigerant tubing and electrical wiring. Additionally, no ductwork means less precious air loss due to leaks. Plus, it delivers a climate-controlled experience directly into one or many rooms of your choice.

---

## WITH HEIL, ROOM-TO-ROOM CLIMATE CONTROL IS A BREEZE

Say goodbye to inconsistent, inaccurate energy distribution. Heil ductless systems provide an efficient, flexible and customizable heating and cooling solution for a single area of a home or business. Our multi-zone solution individually manages several different zones using one integrated system of indoor and outdoor units.

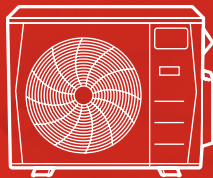

**Single zone systems** provide comfort for areas with as little as 350 and as much as 3,000 square feet—like small offices and bedrooms, or big living and cooking areas.

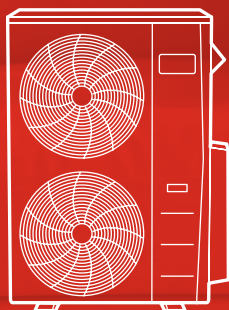

**Multi-zone systems** can connect as many as five indoor units to a single outdoor unit—with comfort all around the house, using individual controls for zoning and energy savings.

## Benefits & Features



### FLEXIBLE & CUSTOMIZABLE

**Streamlined, flexible design** makes Heil ductless systems an ideal solution for many spaces and applications, from new additions and old homes to rooms with insufficient climate control.

- New construction and renovations
- Historic or older homes/buildings with no ductwork
- Homes and businesses
- Single or multi-family
- Primary living areas
- Rooms that are often too hot or too cold
- Basements, attics, garages, additions
- Server rooms



### EASY INSTALLATION

Since no ductwork is necessary, **ductless is the right solution for the most challenging environments**. It's less disruptive to a home or business. Plus, installation is faster because it requires less labor.

- Outdoor units connect to the indoor unit through a small hole (as small as 3 inches). The indoor units are powered by the outdoor unit, so no additional wiring or electrical is required.
- No air ducts needed.



### SMART TECHNOLOGY DESIGNED WITH YOU IN MIND

Integrated sensors (available on some models) can direct airflow toward specific individuals in the room, with the ability to link to third-party thermostats for personalized control.



### ENERGY EFFICIENT

With no ductwork needed, the system doesn't experience the normal energy loss of a traditional HVAC system. Furthermore, indoor units control individual rooms—heating and cooling spaces only when they're in use. This amounts to significant savings on energy bills.

**Our ductless systems utilize inverter compressor technology—allowing each unit to continuously adjust heating and cooling capacities to best match a room's current demand.**



### CONTROL COMFORT FROM ANYWHERE

All indoor units can be made Wi-Fi® compatible with our Wi-Fi® Accessory Kit. Control and monitor your system on the go with the Midea Air app—available from the App Store® and Google Play™.

\*not all products are wi-fi enabled



### EASY-TO-CLEAN AIR FILTERS

Our filters are specifically manufactured for cleaner air quality and reduced allergens. The filtration systems also allow for easy cleaning and replacing.



# THE SWEET SPOT BETWEEN COLD FRONTS & HEAT WAVES

## Show extreme temperatures who's boss.

Our solutions deliver quality performance across a broad range of environments for year-round comfort control. In fact, our ductless systems can heat in temperatures as low as -22° F and cool in those as high as 122° F.



**High wall:** This is the perfect unit for open floor plans, such as a living room, where air easily circulates, and foot traffic is high. Since it sits high on the wall, the unit stays out of the way to give your room more usable space.

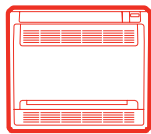

**Console:** Choose this unit for areas like a sunroom or finished attic, with shorter walls and minimal insulation. This unit can mount close to the floor as to not obstruct your view or lighting.

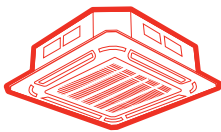

**Cassette:** This is a great solution when you need four-way directional air flow, like in a home office. The unit recesses into the ceiling and can be placed in the center of the room for optimal comfort and control.



**Ducted:** This unit is great when you want to leverage the same ductwork for two or more small spaces, like a bathroom and a closet. It can be installed in the ceiling, floor, or wall to keep the unit hidden while still getting the flexibility of a ductless system.

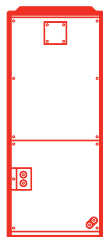







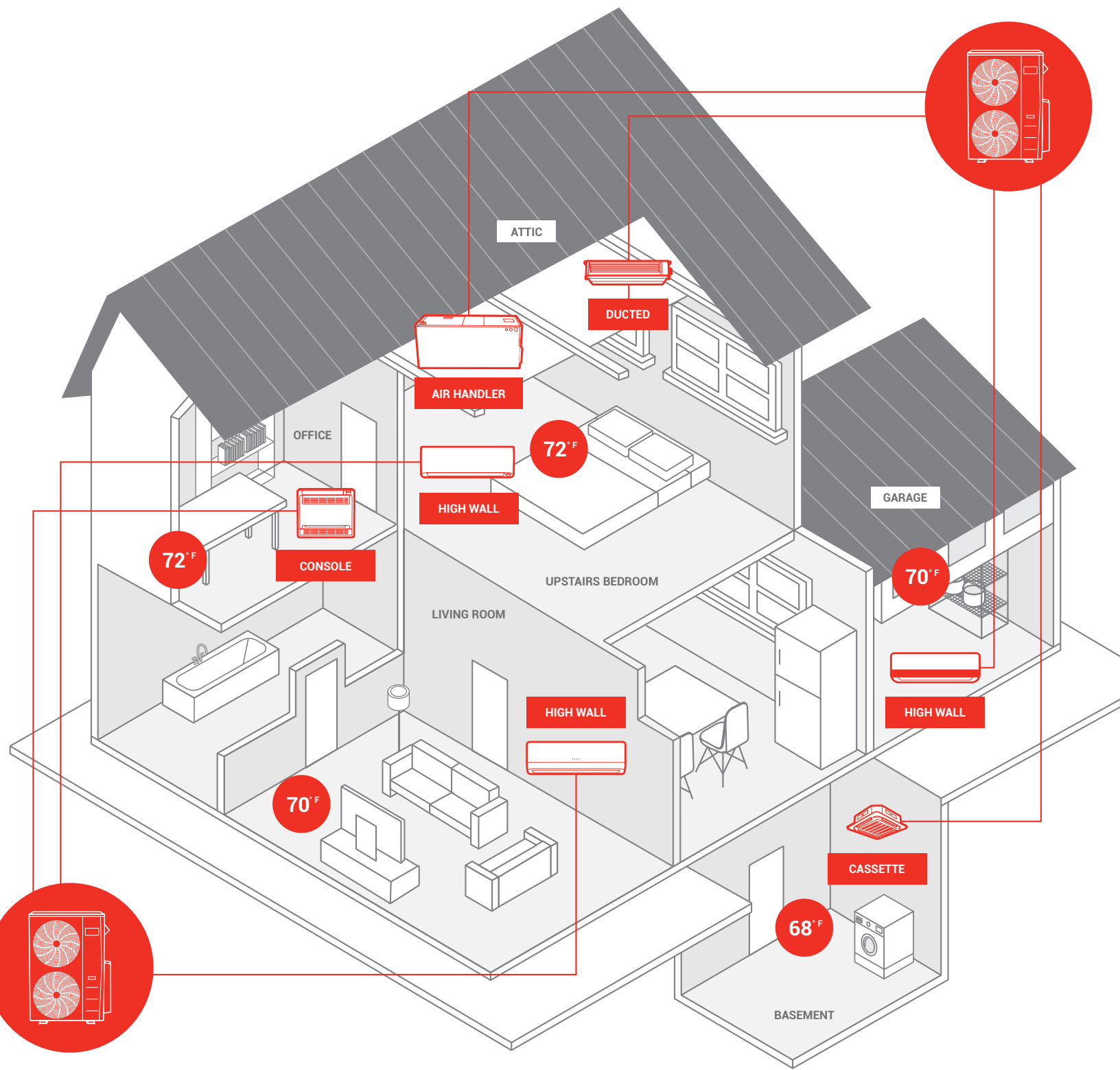



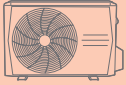

**Air Handler:** A ductless unit that leverages existing ductwork. A perfect replacement for aging or failing indoor units. Enjoy the benefits of ductless technology without completely overhauling your current systems.

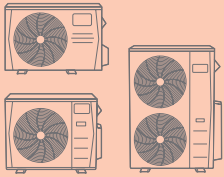

Outdoor units can be strategically placed to minimize noise heard in living spaces or from patios or outdoor gathering spaces. Narrow cabinets make installation possible in small outdoor spaces or on small lots.

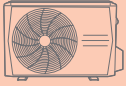

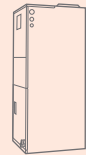
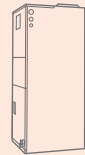

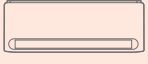
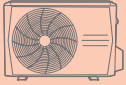
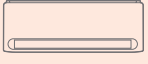
## The Right Product for the Right Application

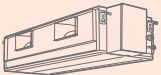
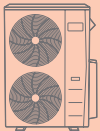
	SINGLE ZONE RESIDENTIAL		MULTI-ZONE	
	Indoor Units	Outdoor Units	Indoor Units	Outdoor Units
<b>DELUXE SERIES</b>	 <b>DLFPHA High Wall</b> Sizes: 09 / 12	 <b>DLCPPRA Outdoor Unit</b> Up to 40.0 SEER Sizes: 09 / 12 / 18 / 24	 <b>DLFPHA High Wall</b> Sizes: 09 / 12	
	 <b>DLFPHA High Wall</b> Sizes: 18 / 24			
<b>QUIET COMFORT SERIES</b>	 <b>DLFSHB High Wall</b> Sizes: 06 / 09 / 12 / 18 / 24 / 30 / 36		 <b>DLFSHB High Wall</b> Sizes: 06 / 09 / 12 / 18 / 24	
	 <b>DLFSCA Cassette</b> Sizes: 09 / 12 / 18 / 24		 <b>DLFSCA Cassette</b> Sizes: 09 / 12 / 18 / 24	
	 <b>DLFSDA Ducted</b> Sizes: 09 / 12 / 18 / 24	 <b>DLCSR Outdoor Unit</b> Up to 25.5 SEER Sizes: 06 / 09 / 12 / 18 / 24 / 30 / 36	 <b>DLFSDA Ducted</b> Sizes: 09 / 12 / 18 / 24	<b>DLCMRA Outdoor Unit</b> Up to 20.5 SEER Sizes: 18 / 27 / 36 / 48
	 <b>DLFSAA Air Handler</b> Sizes: 24		 <b>DLFSAA Air Handler</b> Sizes: 24	
	 <b>DLFSFA Console</b> Sizes: 12 / 18 / 24		 <b>DLFSFA Console</b> Sizes: 12 / 18 / 24	
<b>PERFORMANCE SERIES</b>	 <b>DLFEHA High Wall</b> Sizes: 09 / 12 / 18 / 24	 <b>DLCERB Outdoor Unit</b> Up to 18.8 SEER Sizes: 09 / 12 / 18 / 24	 <b>DLFEHA High Wall</b> Sizes: 09 / 12 / 18 / 24	

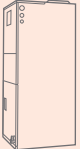
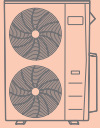
SINGLE ZONE LIGHT COMMERCIAL	
Indoor Units	Outdoor Units
 <p><b>DLFLCA Cassette</b> Sizes: 36 / 48</p>	
 <p><b>DLFLDA Ducted</b> Sizes: 36 / 48 / 58</p>	 <p><b>DLCLRA Outdoor Unit</b> Up to 18.0 SEER Size: 58</p>
 <p><b>DLFLFA Console</b> Sizes: 36 / 48 / 58</p>	
 <p><b>DLFLAA Air Handler</b> Sizes: 36 / 48</p>	 <p><b>DLCLRB Outdoor Unit</b> Up to 16.5 SEER Sizes: 36 / 48</p>

SYSTEM	SIZES	SEER	HSPF	Page
<b>SINGLE ZONE RESIDENTIAL</b>				
<b>DLCPPRA Outdoor Unit</b>	Sizes: 09 / 12 / 18 / 24	Up to 40.0 SEER	Up to 14.5 HSPF	13-14
<b>DLFPHA High Wall</b>	Sizes: 09 / 12			15-16
<b>DLFPHA High Wall</b>	Sizes: 18 / 24			17-18
<b>SINGLE ZONE RESIDENTIAL</b>				
<b>DLCSRB Outdoor Unit</b>	Sizes: 06 / 09 / 12 / 18 / 24 / 30 / 36	Up to 25.5 SEER	Up to 12.7 HSPF	19-22
<b>DLFSHB High Wall</b>	Sizes: 06 / 09 / 12 / 18 / 24 / 30 / 36			23-24
<b>DLFSCA Cassette</b>	Sizes: 09 / 12 / 18 / 24			25-26
<b>DLFSDA Ducted</b>	Sizes: 09 / 12 / 18 / 24			27-28
<b>DLFSFA Console</b>	Sizes: 12 / 18 / 24			29-30
<b>DLFSAA Air Handler</b>	Sizes: 24			31-32
<b>SINGLE ZONE RESIDENTIAL</b>				
<b>DLCERB Outdoor Unit</b>	Sizes: 09 / 12 / 18 / 24	Up to 18.8 SEER	11.0 HSPF	33-36
<b>DLFEHA High Wall</b>	Sizes: 09 / 12 / 18 / 24			37-40
<b>MULTI-ZONE</b>				
<b>DLCMRA Outdoor Unit</b>	Sizes: 18 / 27 / 36 / 48	Up to 20.5 SEER	Up to 10.8 HSPF	45-48
<b>SINGLE ZONE LIGHT COMMERCIAL</b>				
<b>DLCLRA Outdoor Unit</b>	Size: 58	Up to 18.0 SEER	Up to 11.5 HSPF	51-52
<b>DLCLRB Outdoor Unit</b>	Sizes: 36 / 48	Up to 16.5 SEER	Up to 10.4 HSPF	53-56
<b>DLFLCA Cassette</b>	Sizes: 36 / 48			57-58
<b>DLFLDA Ducted</b>	Sizes: 36 / 48 / 58			59-60
<b>DLFLFA Console</b>	Sizes: 36 / 48 / 58			61-62
<b>DLFLAA Air Handler</b>	Sizes: 36 / 48			63-64

# **SINGLE ZONE RESIDENTIAL**



**DLCPRA Outdoor Unit**  
Up to 40.0 SEER  
Sizes: 09 / 12 / 18 / 24



**DLFPHA High Wall**  
Sizes: 09 / 12



**DLFPHA High Wall**  
Sizes: 18 / 24



**DLCSR Outdoor Unit**  
Up to 25.5 SEER  
Sizes: 06 / 09 / 12 / 18 / 24 / 30 / 36



**DLFSHB High Wall**  
Sizes: 06 / 09 / 12 / 18 / 24 / 30 / 36



**DLFSCA Cassette**  
Sizes: 09 / 12 / 18 / 24



**DLFSDA Ducted**  
Sizes: 09 / 12 / 18 / 24



**DLFSFA Console**  
Sizes: 12 / 18 / 24



**DLFSAA Air Handler**  
Size: 24



**DLCERB Outdoor Unit**  
Up to 18.8 SEER  
Sizes: 09 / 12 / 18 / 24



**DLFEHA High Wall**  
09 / 12 / 18 / 24



# A VERSATILE OUTDOOR UNIT FOR PRECISE TEMPERATURE CONTROL

## OUTDOOR FEATURES

- Up to 100% Heating capacity at 0° F (-17° C)
- Up to 100% Cooling capacity at -22° F (-30° C) without additional kit
- Up to 75% of Heating capacity at -22° F (-30° C)
- Available in 208/230V
- Built-in basepan heater
- Auto-restart function
- Refrigerant leakage detection
- Quiet outdoor operation, as low as 55 dB(A)
- Anti-corrosive fin coating
- Piping length 98 ft. (30 m.)
- Cooling operating range -22° ~ 122° F (-30° ~ 50° C)
- Heating operating range -22° ~ 86° F (-25° ~ 30° C)

## COMPATIBLE WITH:

- DLFPHA High Wall (p 15)

## Heat Pump with Basepan Heater

Inverter Compressor

Up to 40.0 SEER

Up to 14.5 HSPF

Sizes: 09 / 12 / 18 / 24

All systems are ENERGY STAR® certified



## KEY FEATURES

### Extra Low Temperature Heating

Heat output up to 75% of rated capacity down to -22° F (-30° C), so when it's cold outside, it will be warm inside.

### Stepless Frequency Adjustment

Precise control maintains stable and constant room temperature while reducing sound level and energy consumption.

## COMPATIBILITY:

Indoor Unit		Outdoor Unit			
		DLCPRAH09AAK	DLCPRAH12AAK	DLCPRAH18AAK	DLCPRAH24AAK
High Wall	DLFPHAH09XAK	•			
	DLFPHAH12XAK		•		
	DLFPHAH18XAK			•	
	DLFPHAH24XAK				•

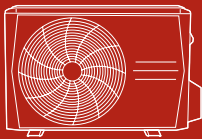

# DELUXE SERIES

## DLCPRA OUTDOOR UNIT

### SPECIFICATIONS:

DLCPRA Outdoor Unit					
Heat Pump					
System					
Size		9	12	18	24
Outdoor Model		DLCPPRAH09AAK	DLCPPRAH12AAK	DLCPPRAH18AAK	DLCPPRAH24AAK
Electrical					
Voltage-Phase-Cycle	V-Ph-Hz	208/230-1-60	208/230-1-60	208/230-1-60	208/230-1-60
MCA	A.	13	15	18	20
MOCP - Fuse Rating	A.	15	20	30	30
Operating Range					
Cooling Outdoor DB Min - Max	° F (° C)	-22~122 (-30~50)	-22~122 (-30~50)	-22~122 (-30~50)	-22~122 (-30~50)
Heating Outdoor DB Min - Max	° F (° C)	-22~86 (-30~30)	-22~86 (-30~30)	-22~86 (-30~30)	-22~86 (-30~30)
Piping					
Total Piping Length	ft (m)	98 (30)	98 (30)	98 (30)	98 (30)
Piping Lift*	ft (m)	49 (15)	49 (15)	65 (20)	65 (20)
Pipe Connection Size - Liquid	in (mm)	1/4 (6.35)	1/4 (6.35)	3/8" (9.52)	3/8" (9.52)
Pipe Connection Size - Suction	in (mm)	3/8 (9.52)	1/2 (12.7)	5/8" (15.9)	5/8" (15.9)
Refrigerant					
Type		R410A	R410A	R410A	R410A
Charge	lbs (kg)	3.5 (1.58)	3.5 (1.58)	5.7 (2.6)	6.5 (2.95)
Outdoor					
Unit Width	in (mm)	33.27 (845)	33.27 (845)	37.24 (946)	37.24 (946)
Unit Height	in (mm)	27.64 (702)	27.64 (702)	31.89 (810)	31.89 (810)
Unit Depth	in (mm)	14.29 (363)	14.29 (363)	16.14 (410)	16.14 (410)
Net Weight	lbs (kg)	107.59 (48.8)	108.47 (49.2)	135.4 (61.4)	145.1 (65.8)
Airflow	CFM	1,380	1,380	2,236	2,236
Sound Pressure	dB(A)	55.5	56.0	61.5	62.0

\*Condensing unit above or below indoor unit.

### PERFORMANCE:

High Wall					
Indoor Model		DLFPHAH09XAK	DLFPHAH12XAK	DLFPHAH18XAK	DLFPHAH24XAK
<b>ENERGY STAR®</b>		<b>YES</b>	<b>YES</b>	<b>YES</b>	<b>YES</b>
Cooling System Tons		0.8	1.0	1.5	1.8
Cooling Rated Capacity	Btu/h	9,000	12,000	18,000	22,000
Cooling Cap. Range Min - Max	Btu/h	5,000~17,000	5,800~19,000	6,888~30,511	7,445~32,644
SEER		40.0	30.0	28.2	23.5
EER		15	13.5	14.5	13.65
Heating Rated Capacity (47° F)	Btu/h	10,000	12,000	18,000	24,000
Heating Rated Capacity (17° F)	Btu/h	7,200	6,800	12,300	15,450
Heating Maximum Capacity (17° F)	Btu/h	15,690	17,070	22,000	22,000
Heating Maximum Capacity (5° F)	Btu/h	13,000	13,800	18,000	24,000
Heating Cap. Range Min - Max	Btu/h	3,100~19,000	3,500~21,000	10,835~29,414	12,050~32,270
HSPF		14.5	13.6	14.0	12.0
COP (47° F)	W/W	4.00	4.24	4.12	3.89
COP (17° F)	W/W	2.78	2.64	3.20	3.00
COP (5° F)	W/W	2.00	2.00	2.00	2.00

Manufacturer reserves the right to discontinue, or change at any time, specification or designs without notice or incurring obligations.

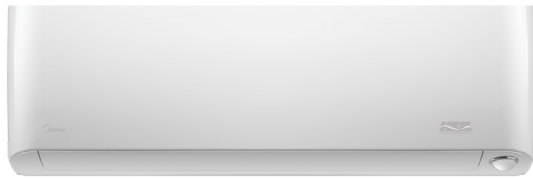

# SUPERIOR COMFORT FROM A SINGLE ENERGY EFFICIENT UNIT

## INDOOR FEATURES

- Available in 208/230V
- Relative Humidity Sensor
- Occupancy Sensor
- Modes: Cool, Heat, Dry, Fan, Auto
- Turbo Mode
- Fully modulating fan speeds
- Sleep Mode
- Up-down / right-left louver control (fixed or swing)
- ECO Mode
- Carbon filter
- Follow Me (senses temperature at handheld remote)
- Heating Setback (46° F Heating Mode)
- Quiet indoor operation, as low as 29 dB(A)
- Anti-corrosive fin coating
- Up to 40.0 SEER and 14.5 HSPF when paired with DLCPRA outdoor unit

## COMPATIBLE WITH:

- DLCPRA Outdoor Unit Single Zone (p 13)
- DLCMRA Outdoor Unit Multi-Zone (p 45)

Sizes: 09 / 12

All systems are ENERGY STAR® certified based on outdoor unit pairing



## KEY FEATURES

### Relative Humidity Sensor

Increase comfort by setting the desired relative humidity in 5% increments in a range of 35% ~ 85%.

### Occupancy Sensor

Detects activity in the room and adjusts the horizontal angle of airflow to blow away from people or follow people.

### Wi-Fi®

Wi-Fi® connectivity is available (see below.)

## CONTROLS

Wireless Remote Controller included with indoor unit

Optional Wired Remote Controller KSACN0601AAA (7-Day Programmable)



**Wireless Remote Controller**



**Wired Controller (7-Day Programmable) KSACN0601AAA**

## ACCESSORIES

Wi-Fi® Kit KSAIF0601AAA

24V Interface for third-party

thermostat compatibility KSAIC0401230







**SPECIFICATIONS:**

<b>DLPFHA High Wall</b>			
<b>Heat Pump</b>			
<b>System</b>			
Size		9	12
Indoor Model		DLPFHAH09XAK	DLPFHAH12XAK
<b>Electrical</b>			
Voltage-Phase-Cycle	V-Ph-Hz	208/230-1-60	208/230-1-60
Power Supply		Indoor Unit Powered From Outdoor Unit	
MCA	A.	0.3	0.3
<b>Operating Range</b>			
Cooling Indoor DB Min - Max	° F (° C)	62~90 (17~32)	62~90 (17~32)
Heating Indoor DB Min - Max	° F (° C)	32~86 (0~30)	32~86 (0~30)
<b>Piping</b>			
Pipe Connection Size - Liquid	in (mm)	1/4 (6.35)	1/4 (6.35)
Pipe Connection Size - Suction	in (mm)	3/8 (9.52)	1/2 (12.7)
<b>Indoor</b>			
Unit Width	in (mm)	35.2 (895)	35.2 (895)
Unit Height	in (mm)	11.7 (298)	11.7 (298)
Unit Depth	in (mm)	9.8 (248)	9.8 (248)
Net Weight	lbs (kg)	37.48 (17)	37.48 (17)
Number of Fan Speeds		4	4
Airflow (lowest to highest)	CFM	144/245/295/345	168/252/306/357
Sound Pressure (lowest to highest)	dB(A)	29/35.5/41.5/45.6	29/35.5/41.5/46.8
Air Throw Data	ft (m)	21.98 (6.7)	22.97 (7)
Moisture Removal	Pint/h (L/h)	2.11 (1.0)	2.53 (1.2)
Field Drain Pipe Size O.D.	in (mm)	1 (25.4)	1 (25.4)

**COMPATIBILITY:**

Indoor Unit	DLPFHAH09XAK	DLPFHAH12XAK
Outdoor Unit Single Zone*	DLCPRAH09AAK	DLCPRAH12AAK
Outdoor Unit Multi-Zone*	DLCMRAH18BAK DLCMRAH27CAK DLCMRAH36DAK DLCMRAH48EAK	

\*Performance may vary based on the compatible outdoor units. See respective pages for performance data.

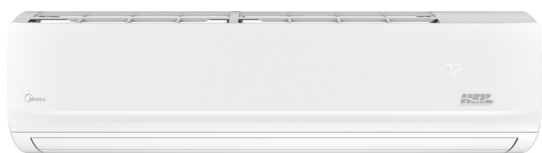

# HIGH EFFICIENCY & PERFORMANCE FOR LARGE SPACES

## INDOOR FEATURES

- Available in 208/230V
- Modes: Cool, Heat, Dry, Fan, Auto
- Turbo Mode
- Fully modulating fan speeds
- Sleep Mode
- Up-down / right-left louver control (fixed or swing)
- Relative Humidity Sensor
- ECO Mode
- Carbon filter
- Follow Me (senses temperature at handheld remote)
- Heating Setback (46° F Heating Mode)
- Quiet indoor operation, as low as 29 dB(A)
- Anti-corrosive fin coating

## COMPATIBLE WITH:

- DLCpra Outdoor Unit Single Zone (p 13)

Sizes: 18 / 24

ENERGY STAR® certified based on outdoor unit pairing



## KEY FEATURES

### Large Residential Applications

A solution for large residential applications where more airflow or load is necessary, such as basements, garages, large living rooms, or even used as a centralized system.

### Light Commercial Applications

With excellent performance and capacity these units can be installed in larger load applications like Restaurants, Offices, and Data Closets / IT rooms.

### Wi-Fi®

Wi-Fi® connectivity is available (see below.)

## CONTROLS

Wireless Remote Controller included with indoor unit

Optional Wired Remote Controller KSACN0601AAA (7-Day programmable)



Wireless Remote Controller



Wired Controller (7-Day Programmable) KSACN0601AAA

## ACCESSORIES

Wi-Fi® Kit KSAIF0601AAA

24V Interface for third-party thermostat compatibility KSAIC0401230





**SPECIFICATIONS:**

<b>DLPFHA High Wall</b>			
<b>Heat Pump</b>			
<b>System</b>			
Size		18	24
Indoor Model		DLPFAH18XAK	DLPFAH24XAK
<b>Electrical</b>			
Voltage-Phase-Cycle	V-Ph-Hz	208/230-1-60	208/230-1-60
Power Supply		Indoor Unit Powered From Outdoor Unit	
MCA	A.	0.5	0.5
<b>Operating Range</b>			
Cooling Indoor DB Min - Max	° F (° C)	62~90 (17~32)	62~90 (17~32)
Heating Indoor DB Min - Max	° F (° C)	32~86 (0~30)	32~86 (0~30)
<b>Piping</b>			
Pipe Connection Size - Liquid	in (mm)	3/8" (9.52)	3/8" (9.52)
Pipe Connection Size - Suction	in (mm)	5/8" (15.9)	5/8" (15.9)
<b>Indoor</b>			
Unit Width	in (mm)	49.57 (1259)	49.57 (1259)
Unit Height	in (mm)	14.25 (362)	14.25 (362)
Unit Depth	in (mm)	11.10 (282)	11.10 (282)
Net Weight	lbs (kg)	43.4 (19.7)	43.4 (19.7)
Number of Fan Speeds		4	4
Airflow (lowest to highest)	CFM	261/389/528/926	359/470/583/926
Sound Pressure (lowest to highest)	dB(A)	35.1/40.8/46.1/55.9	36.1/43.3/46.4/56.5
Air Throw Data	ft (m)	28.80 (8.7)	31.66 (9.65)
Moisture removal	Pint/h (L/h)	3.8 (1.8)	5.0 (2.39)
Field Drain Pipe Size O.D.	in (mm)	1 (25.4)	1 (25.4)

**COMPATIBILITY:**

Indoor Unit	DLPFAH18XAK	DLPFAH24XAK
Outdoor Unit Single Zone*	DLCPRAH18AAK	DLCPRAH24AAK

\*Performance may vary based on the compatible outdoor units. See respective pages for performance data.

**Note:** Indoor units sizes 18-24 not compatible with multi-zone due to the size of the indoor unit coil.

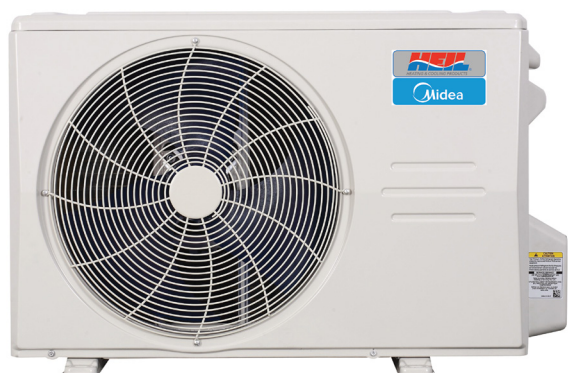

# AN EFFICIENT OUTDOOR UNIT FOR MAXIMUM PERFORMANCE

## OUTDOOR FEATURES

- Up to 100% Heating capacity at -4° F (-20° C)\*
- Up to 100% Cooling capacity at -22° F (-30° C) without additional kit
- Available in 208/230V (6-36K) and 115V (12K)
- Built-in basepan heater
- Auto-restart function
- Anti-corrosive fin coating
- Piping length up to 213 ft (65m)
- Cooling operating range -22° ~ 130° F (-30° ~ 55° C)
- Heating operating range - 22° ~ 86° F (-25° ~ 30° C)

## COMPATIBLE WITH:

- DLFSHB High Wall (p 23)
- DLFSCA Cassette (p 25)
- DLFSDA Ducted (p 27)
- DLFSFA Console (p 29)
- DLFSAA Air Handler (p 31)

## Heat Pump with Basepan Heater

Inverter Compressor

Up to 25.5 SEER

Up to 12.7 HSPF

Sizes: 06/09/12/18/24/30/36 (208-230V);

Size 12 (115V)

Select sizes are ENERGY STAR® certified based on outdoor unit pairing



## KEY FEATURES

### Extra Low Temperature Heating

Heat output up to 69% of rated capacity at -22° F (-30° C). So, when it's cold outside, it will be warm inside.

### Rapid Cooling & Heating

After startup, the compressor quickly gets up to maximum speed, cooling or heating the room in minutes.

\* For certain models.

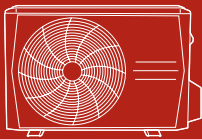

PERFORMANCE:

DLFSHB High Wall									
Size		12	6	9	12	18	24	30	36
Indoor Model		DLFSHBH12XAJ	DLFSHBH06XAK	DLFSHBH09XAK	DLFSHBH12XAK	DLFSHBH18XAK	DLFSHBH24XAK	DLFSHBH30XAK	DLFSHBH36XAK
ENERGY STAR®		YES	YES	YES	YES	YES	YES	NO	NO
Cooling System Tons		1.0	0.5	0.75	1.0	1.5	2.00	2.5	3.0
Cooling Rated Capacity	Btu/h	12,000	6,000	9,000	12,000	18,000	24,000	30,000	36,000
Cooling Cap. Range Min - Max	Btu/h	3,930~13,200	2,490~11,000	3,700~13,300	3,300~13,300	4,500~20,000	7,295~26,600	7,200~31,600	8,300~37,500
SEER		22.0	23.5	25.5	22.0	21.5	21.5	20.0	18.0
EER		12.5	15	15.8	13	13	12.5	12.2	9.5
Heating Rated Capacity (47° F)	Btu/h	12,000	7,000	12,000	12,000	18,000	26,000	30,000	36,000
Heating Rated Capacity (17° F)	Btu/h	8,200	3,600	7,400	12,000	19,000	17,000	17,100	20,000
Heating Maximum Capacity (17° F)	Btu/h	9,018	9,000	12,000	15,000	19,800	24,000	19,700	26,800
Heating Maximum Capacity (5° F)	Btu/h	6,800	7,300	10,000	11,000	18,000	23,000	15,800	20,000
Heating Cap. Range Min - Max	Btu/h	5,000~12,600	2,300~11,200	5,100~14,300	5,100~15,000	5,500~21,000	9,500~27,400	11,700~32,000	10,900~37,000
HSPF		11.5	11.0	12.5	12.7	11.0	11.5	10.0	12.0
COP (47° F)	W/W	3.52	3.76	3.90	3.89	3.35	2.99	3.20	2.78
COP (17° F)	W/W	2.41	2.70	2.90	2.90	1.90	2.49	2.37	2.30
COP (5° F)	W/W	2.00	1.90	1.80	1.64	1.78	1.79	1.68	1.76

PERFORMANCE:

DLFSCA Cassette					
Size		9	12	18	24
Indoor Model		DLFSCAH09XAK	DLFSCAH12XAK	DLFSCAH18XAK	DLFSCAH24XAK
ENERGY STAR®		YES	YES	YES	NO
Cooling System Tons		0.8	1.0	1.3	2.0
Cooling Rated Capacity	Btu/h	9,000	12,000	16,000	24,000
Cooling Cap. Range Min - Max	Btu/h	2,850~11,100	3,000~13,700	5,600~17,000	8,000~25,000
SEER		20.5	21.5	20.0	20.0
EER		13.0	12.7	12.5	11.0
Heating Rated Capacity (47° F)	Btu/h	10,000	12,000	18,000	24,000
Heating Rated Capacity (17° F)	Btu/h	6,650	8,250	11,200	15,100
Heating Maximum Capacity (17° F)	Btu/h	11,800	14,000	21,000	24,200
Heating Maximum Capacity (5° F)	Btu/h	10,200	11,500	17,000	24,100
Heating Cap. Range Min - Max	Btu/h	1,800~12,500	2,000~15,300	8,700~21,000	11,840~27,000
HSPF		10.8	10.6	10.3	11.6
COP (47° F)	W/W	2.93	3.22	2.88	3.50
COP (17° F)	W/W	1.80	2.20	1.80	2.70
COP (5° F)	W/W	1.79	1.86	1.68	1.75

PERFORMANCE:

DLFSDA Ducted					
Size		9	12	18	24
Indoor Model		DLFSDAH09XAK	DLFSDAH12XAK	DLFSDAH18XAK	DLFSDAH24XAK
ENERGY STAR®		YES	YES	YES	YES
Cooling System Tons		0.75	1.0	1.4	2.0
Cooling Rated Capacity	Btu/h	9,000	12,000	16,500	24,000
Cooling Cap. Range Min - Max	Btu/h	2,400~12,500	2,250~14,400	6,500~18,800	6,500~27,800
SEER		23.0	21.5	19.6	20.6
EER		14.0	13.0	12.5	12.5
Heating Rated Capacity (47° F)	Btu/h	10,000	12,000	19,000	24,600
Heating Rated Capacity (17° F)	Btu/h	6,400	8,300	12,700	14,500
Heating Maximum Capacity (17° F)	Btu/h	11,600	12,900	21,500	26,500
Heating Maximum Capacity (5° F)	Btu/h	9,900	12,400	17,800	24,600
Heating Cap. Range Min - Max	Btu/h	1,700~15,600	1,800~16,300	8,900~22,000	12,200~32,200
HSPF		12.0	11.5	11.0	12.6
COP (47° F)	W/W	3.62	3.52	2.93	3.66
COP (17° F)	W/W	1.90	2.00	1.90	2.80
COP (5° F)	W/W	1.78	1.87	1.75	2.01

### PERFORMANCE:

DLFSFA Console						
Size	12		18		24	
Indoor Model	DLFSFAH12XAK		DLFSFAH18XAK		DLFSFAH24XAK	
<b>ENERGY STAR®</b>	YES		YES		NO	
Cooling System Tons	1.0		1.4		2.0	
Cooling Rated Capacity	Btu/h	12,000	17,000		24,000	
Cooling Cap. Range Min - Max	Btu/h	2,800~13,500	7,800~19,900		9,000~26,800	
SEER	23.0		20.2		20.2	
EER	13.0		12.5		11.5	
Heating Rated Capacity (47° F)	Btu/h	12,000	18,000		24,600	
Heating Rated Capacity (17° F)	Btu/h	8,400	12,000		14,500	
Heating Maximum Capacity (17° F)	Btu/h	13,100	20,700		26,661	
Heating Maximum Capacity (5° F)	Btu/h	12,100	16,900		24,100	
Heating Cap. Range Min - Max	Btu/h	2,350~15,700	8,600~21,500		12,500~30,500	
HSPF	11.5		10.6		11.6	
COP (47° F)	W/W	3.22	3.19		3.52	
COP (17° F)	W/W	2	1.80		2.70	
COP (5° F)	W/W	1.84	1.75		1.76	

### PERFORMANCE:

DLFSAA Air Handler		
Size	24	
Indoor Model	DLFSAAH24XAK	
<b>ENERGY STAR®</b>	YES	
Cooling System Tons	1.8	
Cooling Rated Capacity	Btu/h	22,000
Cooling Cap. Range Min - Max	Btu/h	7,500~26,000
SEER	20.0	
EER	12.5	
Heating Rated Capacity (47° F)	Btu/h	27,000
Heating Rated Capacity (17° F)	Btu/h	16,500
Heating Maximum Capacity (17° F)	Btu/h	25,000
Heating Maximum Capacity (5° F)	Btu/h	22,000
Heating Cap. Range Min - Max	Btu/h	5,600~31,000
HSPF	11.6	
COP (47° F)	W/W	3.77
COP (17° F)	W/W	2.60
COP (5° F)	W/W	1.75

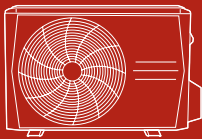

**SPECIFICATIONS:**

DLCSRB Outdoor Unit									
Heat Pump									
System									
Size		12	6	9	12	18	24	30	36
Outdoor Model		DLCSRBH12AAJ	DLCSRBH06AAK	DLCSRBH09AAK	DLCSRBH12AAK	DLCSRBH18AAK	DLCSRBH24AAK	DLCSRBH30AAK	DLCSRBH36AAK
Electrical									
Voltage-Phase-Cycle	V-Ph-Hz	115-1-60	208/230-1-60	208/230-1-60	208/230-1-60	208/230-1-60	208/230-1-60	208/230-1-60	208/230-1-60
MCA	A.	19	13	15	15	16	25	23	28
MOCF - Fuse Rating	A.	25	15	15	15	25	35	30	35
Operating Range									
Cooling Outdoor DB Min - Max	° F (° C)	-22~130 (-30~55)	-22~130 (-30~55)	-22~130 (-30~55)	-22~130 (-30~55)	-22~130 (-30~55)	-22~130 (-30~55)	-22~130 (-30~55)	-22~130 (-30~55)
Heating Outdoor DB Min - Max	° F (° C)	-22~86 (-30~30)	-22~86 (-30~30)	-22~86 (-30~30)	-22~86 (-30~30)	-22~86 (-30~30)	-22~86 (-30~30)	-22~86 (-30~30)	-22~86 (-30~30)
Piping									
Total Piping Length	ft (m)	82 (25)	82 (25)	82 (25)	82 (25)	98 (30)	164 (50)	164 (50)	213 (65)
Piping Lift*	ft (m)	32 (10)	32 (10)	32 (10)	32 (10)	65 (20)	82 (25)	82 (25)	98 (30)
Pipe Connection Size - Liquid	in (mm)	1/4 (6.35)	1/4 (6.35)	1/4 (6.35)	1/4 (6.35)	1/4 (6.35)	3/8 (9.52)	3/8 (9.52)	3/8 (9.52)
Pipe Connection Size - Suction	in (mm)	1/2 (12.7)	3/8 (9.52)	3/8 (9.52)	1/2 (12.7)	1/2 (12.7)	5/8 (16)	5/8 (16)	5/8 (16)
Refrigerant									
Type		R410A	R410A	R410A	R410A	R410A	R410A	R410A	R410A
Charge	lbs (kg)	2.47 (1.12)	2.38 (1.08)	2.6 (1.18)	2.6 (1.18)	4.08 (1.85)	5.73 (2.6)	6.06 (2.75)	7.5 (3.4)
Compressor									
Type		Rotary Inverter	Rotary Inverter	Rotary Inverter	Rotary Inverter	Rotary Inverter	Rotary Inverter	Rotary Inverter	Rotary Inverter
Outdoor									
Unit Width	in (mm)	30.12 (765)	30.12 (765)	31.69 (805)	31.69 (805)	35.04 (890)	37.24 (946)	37.24 (946)	37.24 (946)
Unit Height	in (mm)	21.85 (555)	21.85 (555)	21.81 (554)	21.81 (554)	26.50 (673)	31.89 (810)	31.89 (810)	31.89 (810)
Unit Depth	in (mm)	11.93 (303)	11.93 (303)	12.99 (330)	12.99 (330)	13.46 (342)	16.14 (410)	16.14 (410)	16.14 (410)
Net Weight	lbs (kg)	66.80 (30.3)	63.71 (28.9)	74.07 (33.6)	73.63 (33.4)	100.97 (45.8)	134.48 (61)	141.76 (64.3)	150.13 (68.1)
Airflow	CFM	794	1,324	1,324	1,324	1,765	2,235	2,235	2,235
Sound Pressure	dB(A)	54.0	54.5	54.5	56.0	59.0	62.0	61.5	61.5

\*Condensing unit above or below indoor unit.

**COMPATIBILITY:**

Indoor Unit		Outdoor Unit												
		DLCSRAH12AAJ	DLCSRBH12AAJ	DLCSRBH06AAK	DLCSRBH09AAK	DLCSRAH12AAK	DLCSRBH12AAK	DLCSRAH18AAK	DLCSRBH18AAK	DLCSRAH24AAK	DLCSRBH24AAK	DLCSRAH30AAK	DLCSRBH30AAK	DLCSRAH36AAK
DLFSHBH High Wall*	DLFSHBH12XAJ	•												
	DLFSHBH06XAK		•											
	DLFSHBH09XAK			•										
	DLFSHBH12XAK				•									
	DLFSHBH18XAK					•								
	DLFSHBH24XAK						•							
	DLFSHBH30XAK							•						
DLFSCAH Cassette**	DLFSHBH36XAK												•	
	DLFSCAH09XAK				•									
	DLFSCAH12XAK					•								
	DLFSCAH18XAK						•							
DLFSDAH Ducted**	DLFSCAH24XAK							•						
	DLFSDAH09XAK				•									
	DLFSDAH12XAK					•								
	DLFSDAH18XAK						•							
DLFSFAH Console**	DLFSDAH24XAK							•						
	DLFSFAH12XAK						•							
	DLFSFAH18XAK							•						
DLFSFAH24XAK								•						
DLFSAAH Air Handler	DLFSAAH24XAK								•					

\*Backwards compatible with DLFSHA High Wall

\*\*Cassette, Ducted and Console indoor unit sizes 36, 48 & 58 ONLY compatible with DLCLRB Outdoor Unit.

# A TIME-SAVING DESIGN FOR IMPROVED SERVICEABILITY & EFFICIENCY



## INDOOR FEATURES

- Available in 208/230V (6-36K) or 115V (12K)
- Modes: Cool, Heat, Dry, Fan, Auto
- Turbo Mode
- Four fan speed
- Sleep Mode
- Up-Down Louver control (fixed or swing)
- ECO Mode
- Follow Me Mode
- Heating Setback (46° F Heating Mode)
- Anti-corrosive fin coating

## COMPATIBLE WITH:

- DLCSRB Outdoor Unit Single Zone (p 19)
- DLCMRA Outdoor Unit Multi-Zone (p 45)

Sizes: 06/09/12/18/24/30/36 (208-230V); Size 12 (115V)

Up to 25.5 SEER

Up to 12.7 HSPF



## KEY FEATURES

### Time-saving Design

Bigger wiring terminal & easier wiring connection.

### Customizable Comfort

Compatible with both single and multi-zone outdoor units for maximum flexibility.

## CONTROLS

Wireless Remote Controller included with indoor unit

Optional Wired Remote Controller KSACN0901AAA (7-Day Programmable)



Wireless Remote Controller

Wired Controller (7-Day Programmable) KSACN0901AAA

## ACCESSORIES

Wi-Fi® Kit KSAIF0601AAA

24V Interface for third-party thermostat compatibility KSAIC0401230







**SPECIFICATIONS:**

DLFShB High Wall									
Heat Pump									
System									
Size		12	6	9	12	18	24	30	36
Indoor Model		DLFShBH12XAJ	DLFShBH06XAK	DLFShBH09XAK	DLFShBH12XAK	DLFShBH18XAK	DLFShBH24XAK	DLFShBH30XAK	DLFShBH36XAK
Electrical									
Voltage, Phase, Cycle	V-Ph-Hz	115-1-60	208/230-1-60	208/230-1-60	208/230-1-60	208/230-1-60	208/230-1-60	208/230-1-60	208/230-1-60
Power Supply									
MCA	A.	0.31	0.35	0.19	0.19	0.5	0.5	0.625	0.625
Controls									
Wireless Remote Controller (° F/° C Convertible)		Standard	Standard	Standard	Standard	Standard	Standard	Standard	Standard
Wired Remote Controller (° F/° C Convertible)		Optional	Optional	Optional	Optional	Optional	Optional	Optional	Optional
Operating Range									
Cooling Indoor DB Min - Max	° F(° C)	62~90 (17~32)	62~90 (17~32)	62~90 (17~32)	62~90 (17~32)	62~90 (17~32)	62~90 (17~32)	62~90 (17~32)	62~90 (17~32)
Heating Indoor DB Min - Max	° F(° C)	32~86 (0~30)	32~86 (0~30)	32~86 (0~30)	32~86 (0~30)	32~86 (0~30)	32~86 (0~30)	32~86 (0~30)	32~86 (0~30)
Piping									
Pipe Connection Size - Liquid	in (mm)	1/4 (6.35)	1/4 (6.35)	1/4 (6.35)	1/4 (6.35)	1/4 (6.35)	3/8 (9.52)	3/8 (9.52)	3/8 (9.52)
Pipe Connection Size - Suction	in (mm)	1/2 (12.7)	3/8 (9.52)	3/8 (9.52)	1/2 (12.7)	1/2 (12.7)	5/8 (16)	5/8 (16)	5/8 (16)
Indoor Coil									
Face Area	Sq. Ft.	2.05	2.05	2.05	2.05	2.67	2.67	3.90	3.90
No. Rows		2	2	2	2	2	2	3	3
Fins per inch		20	20	20	20	20	20	20	20
Circuits		2	1.66	2	2	4	4	7	7
Indoor									
Unit Width	in (mm)	31.57 (802)	31.57 (802)	31.57 (802)	31.57 (802)	42.60 (1082)	42.60 (1082)	49.57 (1259)	49.57 (1259)
Unit Height	in (mm)	11.61 (295)	11.61 (295)	11.61 (295)	11.61 (295)	13.27 (337)	13.27 (337)	14.25 (362)	14.25 (362)
Unit Depth	in (mm)	7.87 (200)	7.87 (200)	7.87 (200)	7.87 (200)	9.21 (234)	9.21 (234)	11.14 (283)	11.14 (283)
Net Weight	lbs (kg)	18.96 (8.6)	18.96 (8.6)	18.96 (8.6)	18.96 (8.6)	29.54 (13.4)	29.98 (13.6)	37.48 (19.4)	42.77 (19.4)
Number of Fan Speeds		3	3	3	3	3	3	3	3
Airflow (lowest to highest)	CFM	176/241/300/341	176/196/238/308	152/194/291/341	152/194/291/341	382/458/531/761	382/459/601/761	380/536/702/741	330/447/753/795
Sound Pressure (lowest to highest)	dB(A)	29.8/32.3/38.6	32/33.3/36.9	32.3/35.5/41.2	32.9/35.6/41	37.9/40.9/46.3	41/45.1/49.8	39.3/43.4/49.7	41.3/46.1/53.7
Air Throw Data	ft (m)	23 (7)	15.7 (4.8)	19.7 (6)	22.3 (6.8)	31.8 (9.7)	34.4 (10.5)	36.1 (11)	38.1 (11.6)
Moisture removal	Pint/h (L/h)	2.917 (1.39)	0.833 (0.40)	1.458 (0.69)	3.083 (1.47)	3.625 (1.72)	5.333 (2.54)	7.875 (3.73)	10.625 (5.03)
Field Drain Pipe Size O.D.	in (mm)	0.625 (16)	0.625 (16)	0.625 (16)	0.625 (16)	0.625 (16)	0.625 (16)	0.625 (16)	0.625 (16)

**COMPATIBILITY:**

Indoor Unit	DLFShBH12XAJ	DLFShBH06XAK	DLFShBH09XAK	DLFShBH12XAK	DLFShBH18XAK	DLFShBH24XAK	DLFShBH30XAK	DLFShBH36XAK
Outdoor Unit Single Zone*	DLCSRBH12AAJ	DLCSRBH06AAK	DLCSRBH09AAK	DLCSRBH12AAK	DLCSRBH18AAK	DLCSRBH24AAK	DLCSRBH30AAK	DLCSRBH36AAK
Outdoor Unit Multi-Zone*	DLCMRAH18BAK							
	DLCMRAH27CAK							
	DLCMRAH36DAK							
	DLCMRAH48EAK							

\*Performance may vary based on the Outdoor unit matched to. See compatible Outdoor Units pages for Performance Data



# MAXIMUM FLEXIBILITY FOR OPTIMAL COMFORT CONTROL

## INDOOR FEATURES

- Available in 208/230V
- Up to 22.5 SEER and 12.0 HSPF when paired with DLCSRB outdoor unit
- Modes: Cool, Heat, Dry, Fan, Auto
- Auto-restart function
- Louver control (fixed or swing)
- Three fan speeds
- Outside air intake
- Built-in condensate lift pump
- Follow Me (senses temperature at handheld remote)
- Heating Setback (46° F Heating Mode)
- Quiet indoor operation, as low as 27 dB(A)
- Anti-corrosive fin coating
- Grille/ceiling panel 2' x 2' sizes 09 to 18 KSALG0101AAA
- Grille/ceiling panel 3' x 3' size 24 KSALG0201AAA

## COMPATIBLE WITH:

- DLCSRB Outdoor Unit Single Zone (p 19)
- DLCMRA Outdoor Unit Multi-Zone (p 45)

Sizes: 09 / 12 / 18 / 24

Select sizes are ENERGY STAR® certified based on outdoor unit pairing



## KEY FEATURES

### Built-In Condensate Lift Pump

The cassette is supplied with a condensate lift pump that is capable of lifting the water 29.5 in. (750 mm.) above the top of the unit.

### Integrated Electrical Components

Easy maintenance with the circuit box inside the unit, provides a more compact size for easier installation.

## CONTROLS

Wireless Remote Controller included with indoor unit

Optional Wired Remote Controller KSACN0101AAA (Timer Function)

Wired Remote Controller KSACN0701AAA (7-Day Programmable)



Wireless Remote Controller



Wired Controller (Timer Function) KSACN0101AAA



Wired Controller (7-Day Programmable) KSACN0701AAA

## ACCESSORIES

Wi-Fi® Kit KSAIF0401AAA

24V Interface for third-party thermostat compatibility KSAIC0401230



**NOTE:** Grille is required; sold separately.



**SPECIFICATIONS:**

DLFSCA Cassette					
Heat Pump					
System					
Size		9	12	18	24
Indoor Model		DLFSCAH09XAK	DLFSCAH12XAK	DLFSCAH18XAK	DLFSCAH24XAK
Electrical					
Voltage-Phase-Cycle	V-Ph-Hz	208/230-1-60	208/230-1-60	208/230-1-60	208/230-1-60
Power Supply		Indoor Unit Powered From Outdoor Unit			
MCA	A.	0.2	0.2	0.2	0.3
Operating Range					
Cooling Indoor DB Min - Max	° F (° C)	62~90 (17~32)	62~90 (17~32)	62~90 (17~32)	62~90 (17~32)
Heating Indoor DB Min - Max	° F (° C)	32~86 (0~30)	32~86 (0~30)	32~86 (0~30)	32~86 (0~30)
Piping					
Pipe Connection Size - Liquid	in (mm)	1/4 (6.35)	1/4 (6.35)	1/4 (6.35)	3/8 (9.52)
Pipe Connection Size - Suction	in (mm)	3/8 (9.52)	1/2 (12.7)	1/2 (12.7)	5/8 (16)
Indoor					
Body Unit Width	in (mm)	22.44 (570)	22.44 (570)	22.44 (570)	33.07 (840)
Body Unit Height	in (mm)	10.24 (260)	10.24 (260)	10.24 (260)	8.07 (205)
Body Unit Depth	in (mm)	22.44 (570)	22.44 (570)	22.44 (570)	33.07 (840)
Body Net Weight	lbs (kg)	35.27 (16)	35.27 (16)	39.68 (18)	46.3 (21)
Grille Unit Width	in (mm)	25.47 (647)	25.47 (647)	25.47 (647)	37.4 (950)
Grille Unit Height	in (mm)	1.97 (50)	1.97 (50)	1.97 (50)	2.17 (55)
Grille Unit Depth	in (mm)	25.47 (647)	25.47 (647)	25.47 (647)	37.4 (950)
Grille Net Weight	lbs (kg)	5.51 (2.5)	5.51 (2.5)	5.51 (2.5)	11.02 (5)
Number of Fan Speeds		3	3	3	3
Airflow (lowest to highest)	CFM	270/306/353	253/296/350	439/485/562	625/761/878
Sound Pressure (lowest to highest)	dB(A)	33/35/38	27/34/42	33/40/46.5	47/50/52
Air Throw Data	ft (m)	23 (7)	23 (7)	30 (9)	30 (9)
Moisture Removal	Pint/h (L/h)	1.58 (0.75)	2.88 (1.366)	4.26 (2.02)	5.22 (2.47)
Field Drain Pipe Size O.D.	in (mm)	1 (25.4)	1 (25.4)	1 (25.4)	1 (25.4)

**COMPATIBILITY:**

Indoor Unit	DLFSCAH09XAK	DLFSCAH12XAK	DLFSCAH18XAK	DLFSCAH24XAK
Outdoor Unit Single Zone*	DLC SRBH09AAK	DLC SRBH12AAK	DLC SRBH18AAK	DLC SRBH24AAK
Outdoor Unit Multi-Zone*	DLC MRAH18BAK			
	DLC MRAH27CAK			
	DLC MRAH36DAK			
	DLC MRAH48EAK			

\*Performance may vary based on the compatible outdoor units. See respective pages for performance data.



# FLEXIBLE INSTALLATION & INCREASED AIR CIRCULATION

## INDOOR FEATURES

- Available in 208/230V
- Up to 22.5 SEER and up to 12.0 HSPF when paired with DLCSR outdoor unit
- Modes: Cool, Heat, Dry, Fan, Auto
- Vertical or horizontal installation
- Up to 0.64 in W.C.
- Rear or bottom return
- Variable CFM Operation
- Built-in condensate lift pump
- Follow Me (senses temperature at handheld remote)
- Heating Setback (46° F Heating Mode)
- Quiet indoor operation, as low as 30 dB(A)
- Anti-corrosive fin coating

## COMPATIBLE WITH:

- DLCSR Outdoor Unit Single Zone (p 19)
- DLCMRA Outdoor Unit Multi-Zone (p 45)

Sizes: 09 / 12 / 18 / 24

Select sizes are ENERGY STAR® certified based on outdoor unit pairing



## KEY FEATURES

### Vertical or Horizontal Installation

Designed for maximum installation flexibility with the built-in secondary drain pan, which allows the unit to be mounted vertically for either a floor- or ceiling-concealed installation depending on existing conditions.

### Built-In Condensate Lift Pump

Supplied with a condensate lift pump that is capable of lifting the water a maximum of 29.5 in. (750 mm.) above the top of the unit.

## CONTROLS

Wireless Remote Controller included with indoor unit

Optional Wired Remote Controller KSACN0101AAA (Timer Function)

Wired Remote Controller KSACN0701AAA (7-Day Programmable) included with indoor unit



Wireless Remote Controller



Wired Controller (Timer Function) KSACN0101AAA



Wired Controller (7-Day Programmable) KSACN0701AAA

## ACCESSORIES

Wi-Fi® Kit KSAIF0401AAA

24V Interface for third-party

thermostat compatibility KSAIC0401230





**SPECIFICATIONS:**

DLFSDA Ducted Heat Pump System					
System					
Size		9	12	18	24
Indoor Model		DLFSDAH09XAK	DLFSDAH12XAK	DLFSDAH18XAK	DLFSDAH24XAK
Electrical					
Voltage-Phase-Cycle	V-Ph-Hz	208/230-1-60	208/230-1-60	208/230-1-60	208/230-1-60
Power Supply		Indoor Unit Powered From Outdoor Unit			
MCA	A.	1.11	1.11	1.2	1.2
Operating Range					
Cooling Indoor DB Min - Max	° F (° C)	62~90 (17~32)	62~90 (17~32)	62~90 (17~32)	62~90 (17~32)
Heating Indoor DB Min - Max	° F (° C)	32~86 (0~30)	32~86 (0~30)	32~86 (0~30)	32~86 (0~30)
Piping					
Pipe Connection Size - Liquid	in (mm)	1/4 (6.35)	1/4 (6.35)	1/4 (6.35)	3/8 (9.52)
Pipe Connection Size - Suction	in (mm)	3/8 (9.52)	1/2 (12.7)	1/2 (12.7)	5/8 (16)
Indoor					
Unit Width	in (mm)	27.56 (700)	27.56 (700)	34.65 (880)	43.31 (1100)
Unit Height	in (mm)	7.87 (200)	7.87 (200)	8.27 (210)	9.8 (249)
Unit Depth	in (mm)	19.92 (506)	19.92 (506)	26.54 (674)	30.47 (774)
Net Weight	lbs (kg)	43.56 (19.8)	43.56 (19.8)	54 (24.5)	86.86 (39.4)
Number of Fan Speeds		3	3	3	3
Airflow (lowest to highest)	CFM	147/211/264	176/282/353	300/400/480	440/700/780
Sound Pressure (lowest to highest)	dB(A)	30/34/38	35/37/39	35/37/39	35.5/40/44
Max. Static Pressure	in (W.C.)	0.20	0.20	0.40	0.64
Field Drain Pipe Size O.D.	in (mm)	1 (25.4)	1 (25.4)	1 (25.4)	1 (25.4)

**COMPATIBILITY:**

Indoor Unit	DLFSDAH09XAK	DLFSDAH12XAK	DLFSDAH18XAK	DLFSDAH24XAK
Outdoor Unit Single Zone*	DLCSRBH09AAK	DLCSRBH12AAK	DLCSRBH18AAK	DLCSRBH24AAK
Outdoor Unit Multi-Zone*	DLCMRAH18BAK			
	DLCMRAH27CAK			
	DLCMRAH36DAK			
	DLCMRAH48EAK			

\*Performance may vary based on the compatible outdoor units. See respective pages for performance data.

# A SINGLE CONSOLE FOR OPTIMIZED HEATING & COOLING



## INDOOR FEATURES

- Available in 208/230V
- Up to 22.5 SEER and 12.0 HSPF when paired with DLCSRB outdoor unit
- Modes: Cool, Heat, Dry, Fan, Auto
- Auto-restart function
- Size 12 capable of being mounted on floor only
- Sizes 18-24 capable of being mounted on floor or ceiling
- Louver control (fixed or swing)
- Three fan speeds
- Air discharge from top and bottom (size 12 only)
- Follow Me (senses temperature at handheld remote)
- Heating Setback (46° F Heating Mode)
- Quiet indoor operation, as low as 34 dB(A)
- Anti-corrosive fin coating

## COMPATIBLE WITH:

- DLCSRB Outdoor Unit Single Zone (p 19)
- DLCMRA Outdoor Unit Multi-Zone (p 45)

Sizes: 12 / 18 / 24

Select sizes are ENERGY STAR® certified based on outdoor unit pairing



## KEY FEATURES

### 2-Way Optional Air Outlet

For up and down air-outlet or up air-outlet. Only on size 12.

### Outside Air Intake

Outside air can be brought into the room through the connection available on the indoor unit, which can help meet possible ventilation requirements. Only on sizes 18-24.

## CONTROLS

Wireless Remote Controller included with indoor unit

Optional Wired Remote Controller KSACN0101AAA (Timer Function)

Optional Wired Remote Controller KSACN0601AAA (7-Day Programmable) size 12

Optional Wired Remote Controller KSACN0701AAA (7-Day Programmable) sizes 18 and 24



Wireless Remote Controller



Wired Controller (Timer Function) KSACN0101AAA



Wired Controller (7-Day Programmable) KSACN0601AAA or KSACN0701AAA

## ACCESSORIES

Wi-Fi® Kit (sizes 18-24) KSAIF0401AAA\*

24V Interface for third-party thermostat compatibility KSAIC0401230



\*Not available for size 12.



**SPECIFICATIONS:**

<b>DLFSFA Console</b>				
<b>Heat Pump</b>				
<b>System</b>				
Size		12	18	24
Indoor Model		DLFSFAH12XAK	DLFSFAH18XAK	DLFSFAH24XAK
<b>Electrical</b>				
Voltage-Phase-Cycle	V-Ph-Hz	208/230-1-60	208/230-1-60	208/230-1-60
Power Supply		Indoor Unit Powered From Outdoor Unit		
MCA	A.	0.3	1.0	1.0
<b>Operating Range</b>				
Cooling Indoor DB Min - Max	° F (° C)	62~90 (17~32)	62~90 (17~32)	62~90 (17~32)
Heating Indoor DB Min - Max	° F (° C)	32~86 (0~30)	32~86 (0~30)	32~86 (0~30)
<b>Piping</b>				
Pipe Connection Size - Liquid	in (mm)	1/4 (6.35)	1/4 (6.35)	3/8 (9.52)
Pipe Connection Size - Suction	in (mm)	1/2 (12.7)	1/2 (12.7)	5/8 (16)
<b>Indoor</b>				
Unit Width	in (mm)	27.56 (700)	42.05 (1068)	42.05 (1068)
Unit Height	in (mm)	23.62 (600)	26.57 (675)	26.57 (675)
Unit Depth	in (mm)	8.27 (210)	9.25 (235)	9.25 (235)
Net Weight	lbs (kg)	32.41 (14.7)	55.12 (25)	58.42 (26.5)
Number of Fan Speeds		3	3	3
Airflow (lowest to highest)	CFM	250/320/360	420/485/550	600/710/760
Sound Pressure (lowest to highest)	dB(A)	34/41/45	39/44/47	46/50/52
Air Throw Data	ft (m)	23 (7)	26 (8)	21.75 (6.63)
Field Drain Pipe Size O.D.	in (mm)	1 (25.4)	1 (25.4)	1 (25.4)

**COMPATIBILITY:**

Indoor Unit	DLFSFAH12XAK	DLFSFAH18XAK	DLFSFAH24XAK
Outdoor Unit Single Zone*	DLCSR12AAK	DLCSR18AAK	DLCSR24AAK
Outdoor Unit Multi-Zone*	DLCMRAH18BAK		
	DLCMRAH27CAK		
	DLCMRAH36DAK		
	DLCMRAH48EAK		

\*Performance may vary based on the compatible outdoor units. See respective pages for performance data.



# A MULTI-POISE AIR HANDLER FOR MAXIMUM FLEXIBILITY

## INDOOR FEATURES

- Modes: Cool, Heat, Dry, Fan, Auto
- Up to 20.0 SEER and 10.4 HSPF based on outdoor unit pairing
- Multi poise installation (Up Flow, Down Flow, Horizontal Right, Horizontal Left)
- Total system static pressure up to 0.8 in. W.C.
- Less than 2% air leakage
- Quiet indoor operation
- Built-in third-party thermostat compatibility
- Anti-corrosive fin coating
- Extreme heating operation in as low as -22° F (-30° C) based on outdoor unit pairing
- Optional Electric Heat Packages available (5, 10, 15 and 20 KW)

## COMPATIBLE WITH:

- DLCSRB Outdoor Unit Single Zone (p 19)
- DLCMRA Outdoor Unit Multi-Zone (p 45)
- DLCLRB Outdoor Unit Single Zone (p 53)

Size: 24 / 36 / 48

Select sizes are ENERGY STAR® certified based on outdoor unit pairing



## KEY FEATURES

### Installation Flexibility

A built-in secondary drain allows the unit to be mounted vertically (up flow or down flow) or horizontally (left or right), enabling multi-position installation. All three sizes are capable of operating as traditional central ducted systems when paired with a compatible single zone outdoor unit.

### Multi-Zone Compatibility

The size 24 air handler can connect to select multi-zone outdoor units to create one integrated system, enabling unique zoned comfort and efficiency.

### Efficient Comfort

As an alternate to gas furnaces, reduce the use of fossil fuels and experience cleaner energy and efficiency levels that meet many local and federal requirements.

## CONTROLS

Factory installed 24V interface for third-party thermostat compatibility\*

## ACCESSORIES

Electric Heat Packages EHKMA05KN, EHKMA10KN, EHKMA15KN, EHKMA20KN

Only Size 24 is available for multi-zone applications.

\*See installation instructions for details





**SPECIFICATIONS:**

DLFSA & DLFLAA Air Handler				
Heat Pump				
System				
Size		24	36	48
Indoor Model		DLFSAAH24XAK	DLFLAAH36XAK	DLFLAAH48XAK
Electrical				
Voltage-Phase-Cycle	V-Ph-Hz	208/230-1-60	208/230-1-60	208/230-1-60
Power Supply		Indoor Unit Powered by Outdoor Unit		
MCA	A.	5	5	5
Controls				
Wireless Remote Controller (° F/° C Convertible)		Standard	Standard	Standard
Third-Party Thermostat Compatability		Standard	Standard	Standard
Operating Range				
Cooling Indoor DB Min - Max	° F (° C)	62~90 (17~32)	62~90 (17~32)	62~90 (17~32)
Heating Indoor DB Min - Max	° F (° C)	32~86 (0~30)	32~86 (0~30)	32~86 (0~30)
Piping				
Pipe Connection Size - Liquid	in (mm)	3/8 (9.52)	3/8 (9.52)	3/8 (9.52)
Pipe Connection Size - Suction	in (mm)	5/8 (16)	5/8 (16)	5/8 (16)
Indoor				
Unit Width	in (mm)	19.6 (498)	19.6 (498)	19.6 (498)
Unit Height	in (mm)	48.8 (1,240)	48.8 (1,240)	48.8 (1,240)
Unit Depth	in (mm)	21.0 (533)	21.0 (533)	21.0 (533)
Net Weight	lbs (kg)	141.1 (64)	144.8 (65.7)	144.8 (65.7)
Number of Fan Speeds		4	4	4
Airflow (lowest to highest)	CFM	588/765/882	824/1,000/1,176	1,176/1,294/1,412
Sound Pressure - Cooling (lowest to highest)	dB(A)	37.2/40.4/43/45.2	37.2/40.4/43/45.2	37.2/40.4/43/45.2
Sound Pressure - Heating (lowest to highest)	dB(A)	35.8/38.7/41.7	37.9/43/46.5/48	50/51.9/53.9/54.9
Max Static Pressure	in. W.C.	0.80	0.80	0.80
Field Drain Pipe Size O.D.	in (mm)	3/4 (19.1)	3/4 (19.1)	3/4 (19.1)

\*Performance may vary based on the compatible outdoor units. See respective pages for performance data.

**COMPATIBILITY:**

Indoor Unit		Outdoor Unit Single Zone			Outdoor Unit Multi-Zone	
		DLCSR BH24AAK	DLCLRBH36AAK	DLCLRBH48AAK	DLCMRAH36DAK	DLCMRAH48EAK
DLFSA Air Handler	DLFSAAH24XAK	•			•	•
DLFLAA Air Handler	DLFLAAH36XAK		•			
	DLFLAAH48XAK			•		

**Multi-zone configuration:**

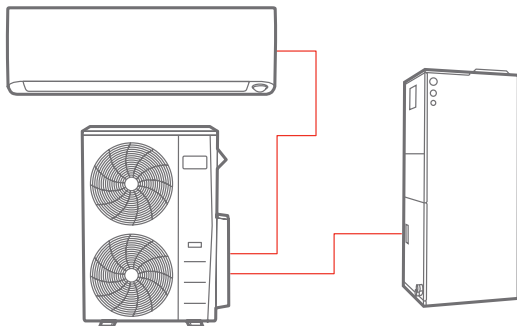

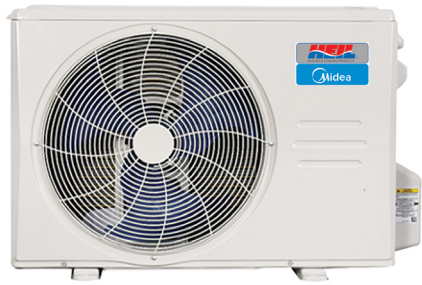

# A COST-EFFECTIVE OUTDOOR UNIT FOR MAXIMUM INDOOR COMFORT

## OUTDOOR FEATURES

- Cost competitive
- Factory installed basepan heater
- Factory installed crankcase heater
- Auto-restart function
- Condenser high-temperature protection
- Refrigerant leakage detection
- Quiet outdoor operation
- Anti-corrosive fin coating

## COMPATIBLE WITH:

- DLFEHAA High Wall Cooling Only (p 37)
- DLFEHAH High Wall Heat Pump (p 37)

## Cooling Only - DLCERBA

### Heat Pump with Basepan Heater - DLCERBH

Sizes: 09 / 12 / 18 / 24 (208-230V); Size 12 (115V)

Up to 18.8 SEER

Up to 11.0 HSPF

## KEY FEATURES

### Easy Maintenance

Simple and fast installation and maintenance means less system downtime and costs.

### Small Physical Size

With an optimized cabinet design and small footprint, the unit is unobtrusive and quiet.

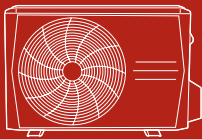

**SPECIFICATIONS:**

DLCERB Outdoor Unit						
Heat Pump						
System						
Size		12	9	12	18	24
Outdoor Model		DLCERBH12AAJ	DLCERBH09AAK	DLCERBH12AAK	DLCERBH18AAK	DLCERBH24AAK
Electrical						
Voltage-Phase-Cycle	V-Ph-Hz	115-1-60	208/230-1-60	208/230-1-60	208/230-1-60	208/230-1-60
MCA	A.	18.5	12	15	15	19
MOCP - Fuse Rating	A.	25	15	15	20	30
Operating Range						
Cooling Outdoor DB Min - Max	° F (° C)	0~122 (-17~50)	0~122 (-17~50)	0~122 (-17~50)	0~122 (-17~50)	0~122 (-17~50)
Heating Outdoor DB Min - Max	° F (° C)	0~86 (-17~30)	0~86 (-17~30)	0~86 (-17~30)	0~86 (-17~30)	0~86 (-17~30)
Piping						
Total Piping Length	ft (m)	82 (25)	82 (25)	82 (25)	98 (30)	164 (50)
Piping Lift*	ft (m)	32 (10)	32 (10)	32 (10)	65 (20)	82 (25)
Pipe Connection Size - Liquid	in (mm)	1/4 (6.35)	1/4 (6.35)	1/4 (6.35)	1/4 (6.35)	3/8 (9.52)
Pipe Connection Size - Suction	in (mm)	1/2 (12.7)	3/8 (9.52)	1/2 (12.7)	1/2 (12.7)	5/8 (16)
Refrigerant						
Type		R410A	R410A	R410A	R410A	R410A
Charge	lbs (kg)	1.79 (0.81)	1.59 (0.72)	1.79 (0.81)	2.98 (1.35)	3.92 (1.78)
Compressor						
Type		Rotary Inverter	Rotary Inverter	Rotary Inverter	Rotary Inverter	Rotary Inverter
Outdoor						
Unit Width	in (mm)	30.12 (765)	30.12 (765)	30.12 (765)	31.69 (805)	35.04 (890)
Unit Height	in (mm)	21.85 (555)	21.85 (555)	21.85 (555)	21.81 (554)	26.50 (673)
Unit Depth	in (mm)	11.93 (303)	11.93 (303)	11.93 (303)	12.99 (330)	13.46 (342)
Net Weight	lbs (kg)	62.17 (28.2)	55.11 (25.0)	59.30 (26.9)	73.85 (33.5)	97.88 (44.4)
Airflow	CFM	1,235	1,294	1,235	1,235	1,765
Sound Pressure	dB(A)	53.5	55.0	55.5	55.0	59.5

\*Condensing unit above or below indoor unit.

**COMPATIBILITY:**

Indoor Unit		Outdoor Unit				
		DLCERBH12AAJ	DLCERBH09AAK	DLCERBH12AAK	DLCERBH18AAK	DLCERBH24AAK
DLFEHAH High Wall	DLFEHAH12XAJ	•				
	DLFEHAH09XAK		•			
	DLFEHAH12XAK			•		
	DLFEHAH18XAK				•	
	DLFEHAH24XAK					•

**PERFORMANCE:**

DLFEHAH High Wall						
Heat Pump						
Indoor Model		DLFEHAH12XAJ	DLFEHAH09XAK	DLFEHAH12XAK	DLFEHAH18XAK	DLFEHAH24XAK
ENERGY STAR®		NO	NO	NO	NO	NO
Cooling System Tons		1.0	0.8	1.0	1.5	2.0
Cooling Rated Capacity	Btu/h	12,000	9,000	12,000	18,000	24,000
Cooling Cap. Range Min - Max	Btu/h	4,500~12,100	2,650~9,500	3,300~13,000	3,760~19,900	6,760~24,300
SEER		18.8	17.6	18.8	18.0	18.0
EER		9.9	11.2	10.2	11.2	9.4
Heating Rated Capacity (47° F)	Btu/h	12,000	10,000	12,000	18,000	24,800
Heating Rated Capacity (17° F)	Btu/h	7,000	5,800	7,000	11,900	15,300
Heating Maximum Capacity (5° F)	Btu/h	7,000	6,500	8,000	10,000	14,000
Heating Cap. Range Min - Max	Btu/h	5,500~12,000	2,600~10,500	3,810~13,490	6,400~19,000	6,040~26,210
HSPF		10.8	10	10	11	10.2
COP (47° F)	W/W	3.00	3.30	3.11	3.20	3.13
COP (17° F)	W/W	2.35	2.25	2.50	2.72	2.62
COP (5° F)	W/W	1.60	1.75	1.75	2.00	1.75

**PERFORMANCE:**

DLFEHAA High Wall					
Cooling Only					
Indoor Model		DLFEHAA12XBJ	DLFEHAA12XBK	DLFEHAA18XAK	DLFEHAA24XAK
ENERGY STAR®		NO	NO	NO	NO
Cooling System Tons		1.0	1.0	1.4	2.0
Cooling Rated Capacity	Btu/h	11,500	11,500	17,000	24,000
Cooling Cap. Range Min - Max	Btu/h	3,200~12,800	3,200~12,900	4,500~18,000	6,760~24,300
SEER		20.5	20.5	19.0	17.1
EER		11.2	11.2	10.9	9.3

An economical choice that can **provide comfort when you need it.**

Manufacturer reserves the right to discontinue, or change at any time, specification or designs without notice or incurring obligations.

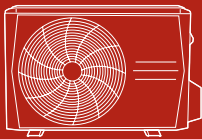

**SPECIFICATIONS:**

DLCERAA Outdoor Unit					
Cooling Only					
System					
Size		12	12	18	24
Outdoor Model		DLCERBA12AAJ	DLCERBA12AAK	DLCERBA18AAK	DLCERAA24AAK
Electrical					
Voltage-Phase-Cycle	V-Ph-Hz	115-1-60	208/230-1-60	208/230-1-60	208/230-1-60
MCA	A.	19	9	19	19
MOCP - Fuse Rating	A.	30	15	30	30
Operating Range					
Cooling Outdoor DB Min - Max	° F (° C)	0~122 (-17~50)	0~122 (-17~50)	0~122 (-17~50)	0~122 (-17~50)
Piping					
Total Piping Length	ft (m)	82 (25)	82 (25)	98 (30)	164 (50)
Piping Lift*	ft (m)	33 (10)	33 (10)	66 (20)	66 (20)
Pipe Connection Size - Liquid	in (mm)	1/4 (6.35)	1/4 (6.35)	1/4 (6.35)	3/8 (9.52)
Pipe Connection Size - Suction	in (mm)	1/2 (12.7)	1/2 (12.7)	1/2 (12.7)	5/8 (16)
Refrigerant					
Type		R410A	R410A	R410A	R410A
Charge	lbs (kg)	1.43 (0.65)	1.43 (0.65)	1.98 (0.9)	3.92 (1.78)
Compressor					
Type		Rotary Inverter	Rotary Inverter	Rotary Inverter	Rotary Inverter
Outdoor					
Unit Width	in (mm)	28.35 (720)	28.35 (720)	30.12 (765)	35.04 (890)
Unit Height	in (mm)	19.49 (495)	19.49 (495)	21.85 (555)	26.50 (673)
Unit Depth	in (mm)	10.63 (270)	10.63 (270)	11.93 (303)	13.46 (342)
Net Weight	lbs (kg)	51.15 (23.2)	48.72 (22.1)	61.51 (27.9)	97.88 (44.4)
Airflow	CFM	1,059	1,059	1,235	1,765
Sound Pressure	dB(A)	52.0	52.5	55.5	59.5

\*Condensing unit above or below indoor unit.

**COMPATIBILITY:**

Indoor Unit		Outdoor Unit			
		DLCERBA12AAJ	DLCERBA12AAK	DLCERBA18AAK	DLCERBA24AAK
DLFEHAA High Wall	DLFEHAA12XBJ	•			
	DLFEHAA12XBK		•		
	DLFEHAA18XAK			•	
	DLFEHAA24XAK				•

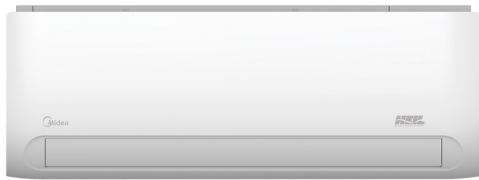

# EASY INSTALLATION FOR MAXIMUM CONVENIENCE & COMFORT

## INDOOR FEATURES

- Available in 115V and 208/230V
- Up to 17.6 SEER and up to 10.6 HSPF when paired with DLCERB outdoor unit
- Modes: Cool, Heat, Dry, Fan, Auto
- Turbo Mode
- Up-down louver control (fixed or swing)
- Remove filter from the top
- Improved serviceability
- Four fan speeds
- Sleep Mode
- Follow Me (senses temperature at handheld remote)
- Heating Setback (46° F Heating Mode)
- Quiet indoor operation, as low as 29 dB(A)
- Anti-corrosive fin coating

## COMPATIBLE WITH:

- DLCERB Outdoor Unit Single Zone (p 33)
- DLCMRA Outdoor Unit Multi-Zone (p 45)

## Cooling Only – DLFEHAA

## Heat Pump – DLFEHAH

Sizes: 09 / 12 / 18 / 24

## KEY FEATURES

### Improved Serviceability

Full access to the terminal connections and fan after lifting the front cover of the high wall for easy installation and service.

### Convenient Filter Removal

The filter is located on the inlet, allowing for direct removal from the top of the unit without opening the cover.

## CONTROLS

Wireless Remote Controller included with indoor unit  
Optional Wired Remote Controller KSACN0601AAA (7-Day Programmable)



**Wireless  
Remote Controller**



**Wired Controller  
(7-Day Programmable)  
KSACN0601AAA**

## ACCESSORIES

Wi-Fi® High Wall Entry Tier 9/12/24  
KSAIF0101AAA

Wi-Fi® High Wall Entry Tier 18k Only KSAIF0201AAA

24V Interface for third-party  
thermostat compatibility KSAIC0401230





**SPECIFICATIONS:**

DLFEHAA High Wall					
Cooling Only System					
Size		12	12	18	24
Indoor Model		DLFEHAA12XAJ	DLFEHAA12XAK	DLFEHAA18XAK	DLFEHAA24XAK
Electrical					
Voltage-Phase-Cycle	V-Ph-Hz	115-1-60	208/230-1-60	208/230-1-60	208/230-1-60
Power Supply		Indoor Unit Powered From Outdoor Unit			
MCA	A.	0.2	0.1	0.27	0.4
Controls					
Wireless Remote Controller (° F / ° C Convertible)		Standard	Standard	Standard	Standard
Wired Remote Controller (° F / ° C Convertible)		Optional	Optional	Optional	Optional
Operating					
Cooling Indoor DB Min - Max	° F (° C)	62~90 (17~32)	62~90 (17~32)	62~90 (17~32)	62~90 (17~32)
Piping					
Pipe Connection Size - Liquid	in (mm)	1/4 (6.35)	1/4 (6.35)	1/4 (6.35)	3/8 (9.52)
Pipe Connection Size - Suction	in (mm)	1/2 (12.7)	1/2 (12.7)	1/2 (12.7)	5/8 (16)
Indoor					
Unit Width	in (mm)	32.00 (813)	32.00 (813)	38.36 (974)	43.83 (1113)
Unit Height	in (mm)	11.81 (300)	11.81 (300)	12.8 (325)	13.41 (341)
Unit Depth	in (mm)	7.75 (197)	7.75 (197)	8.87 (225)	9.22 (234)
Net Weight	lb (kg)	19.62 (8.9)	19.62 (8.9)	25.35 (11.5)	33.29 (15.1)
Number of Fan Speeds		4	4	4	4
Airflow (lowest to highest)	cfm	198/237/331/362	191/237/334/362	344/422/505/505	418/506/600/629
Sound Pressure (lowest to highest)	dB(A)	27/33/42/44	29/33/42/45	36/40/44/45	35/41/46/48
Air Throw Data	ft (m)	22 (6.7)	22 (6.7)	24 (7.3)	39.4 (12)
Moisture Removal	Pint/h (L/h)	3.17 ( 1.50)	3.09 ( 1.46)	4.38 (2.07)	6.38 (3.02)
Field Drain Pipe Size O.D.	in (mm)	5/8 (16)	5/8 (16)	5/8 (16)	5/8 (16)

\*Compatibility tables on next page.

### SPECIFICATIONS:

DLFEHAH High Wall						
Heat Pump						
System						
Size		12	9	12	18	24
Indoor Model		DLFEHAH12XAJ	DLFEHAH09XAK	DLFEHAH12XAK	DLFEHAH18XAK	DLFEHAH24XAK
Electrical						
Voltage-Phase-Cycle	V-Ph-Hz	115-1-60	208/230-1-60	208/230-1-60	208/230-1-60	208/230-1-60
Power Supply		Indoor Unit Powered From Outdoor Unit				
MCA	A.	0.3	0.25	0.25	0.28	0.45
Controls						
Wireless Remote Controller (° F / ° C Convertible)		Standard	Standard	Standard	Standard	Standard
Wired Remote Controller (° F / ° C Convertible)		Optional	Optional	Optional	Optional	Optional
Operating						
Cooling Indoor DB Min - Max	° F (° C)	63~90 (17~32)	63~90 (17~32)	63~90 (17~32)	63~90 (17~32)	63~90 (17~32)
Heating Indoor DB Min - Max	° F (° C)	32~86 (0~30)	32~86 (0~30)	32~86 (0~30)	32~86 (0~30)	32~86 (0~30)
Piping						
Pipe Connection Size - Liquid	in (mm)	1/4 (6.35)	1/4 (6.35)	1/4 (6.35)	1/4 (6.35)	3/8 (9.52)
Pipe Connection Size - Suction	in (mm)	1/2 (12.7)	3/8 (9.52)	1/2 (12.7)	1/2 (12.7)	5/8 (16)
Indoor						
Unit Width	in (mm)	32.00 (813)	28.53 (725)	32.00 (813)	38.36 (974)	43.83 (1113)
Unit Height	in (mm)	11.81 (300)	11.81 (300)	11.81 (300)	12.8 (325)	13.41 (341)
Unit Depth	in (mm)	7.75 (197)	7.75 (197)	7.75 (197)	8.87 (225)	9.22 (234)
Net Weight	lbs (kg)	22.49 (10.2)	21.16 (9.6)	22.49 (10.2)	31.97 (14.5)	40.12 (18.2)
Number of Fan Speeds		4	4	4	4	4
Airflow (lowest to highest)	CFM	200/265/306/ 329	165/229/271/ 324	212/282/324/ 353	353/412/529/ 559	353/483/589/ 647
Sound Pressure (lowest to highest)	dB(A)	29/38/42/42	31/36/40/42	34/39/41/43	34/39/44/46	38/42/48/49
Air Throw Data	ft (m)	22 (6.7)	20.3 (6.2)	22.6 (6.9)	25 (7.6)	37.7 (11.5)
Moisture Removal	Pint/h (L/h)	3.49 (1.65)	2.05 (0.97)	3.38 (1.6)	4.63 (2.19)	5.73 (2.71)
Field Drain Pipe Size O.D.	in (mm)	0.625 (16)	0.625 (16)	0.625 (16)	0.625 (16)	0.625 (16)

\*Compatibility tables on next page.





**COMPATIBILITY:**

Cooling Only				
Indoor Unit	DLFEHAA12XBJ	DLFEHAA12XBK	DLFEHAA18XAK	DLFEHAA24XAK
Outdoor Unit Single Zone*	DLCERBA12AAJ	DLCERBA12AAK	DLCERBA18AAK	DLCERBA24AAK
Outdoor Unit Multi-Zone*				

\*Performance may vary based on the compatible outdoor units. See respective pages for performance data.

**COMPATIBILITY:**

Heat Pump					
Indoor Unit	DLFEHAH12XAJ	DLFEHAH09XAK	DLFEHAH12XAK	DLFEHAH18XAK	DLFEHAH24XAK
Outdoor Unit Single Zone*	DLCERBH12AAJ	DLCERBH09AAK	DLCERBH12AAK	DLCERBH18AAK	DLCERBH24AAK
Outdoor Unit Multi-Zone*		DLCMRAH18BAK			
		DLCMRAH27CAK			
		DLCMRAH36DAK			
		DLCMRAH48EAK			

\*Performance may vary based on the compatible outdoor units. See respective pages for performance data.

# BETTER INSTALLATION, SERVICE & MAINTENANCE FOR A BETTER HVAC EXPERIENCE

We take pride in providing easy-to-use ductless solutions that offer simplified and flexible installation and maintenance. Now, with an improved mounting frame, a more flexible unit design and better filter access, we've made the installation, service and maintenance of our entry tier indoor units easier than ever.



## IMPROVED MOUNTING

- New hook design on the mounting frame allows for a two-inch shift to the left and right
- High wall paper template helps with installation
- Kick-stands lift the frame to provide easier access to piping, drain connections and wiring



## ENHANCED UNIT DESIGN

- Rotatable front panel for easier installation and maintenance
- Removable chassis for quicker cleaning and replacement of the fan motor
- With only four screws to remove, significantly reduce maintenance time



## EASIER FILTER ACCESS

- Filter located on the inlet for removal from the top of the unit
- No need to forcibly open the front panel to remove, and potentially bend, the filter

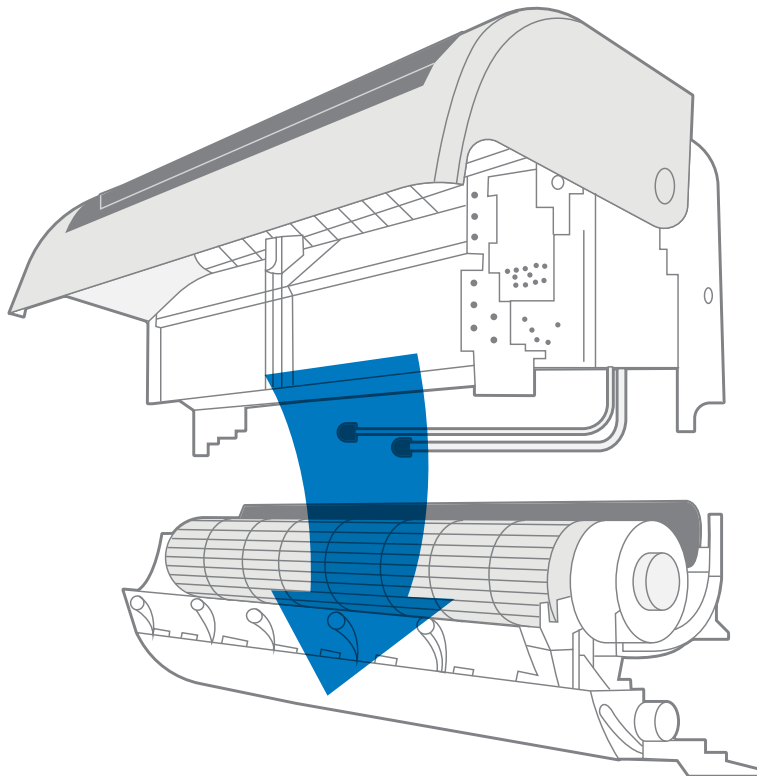
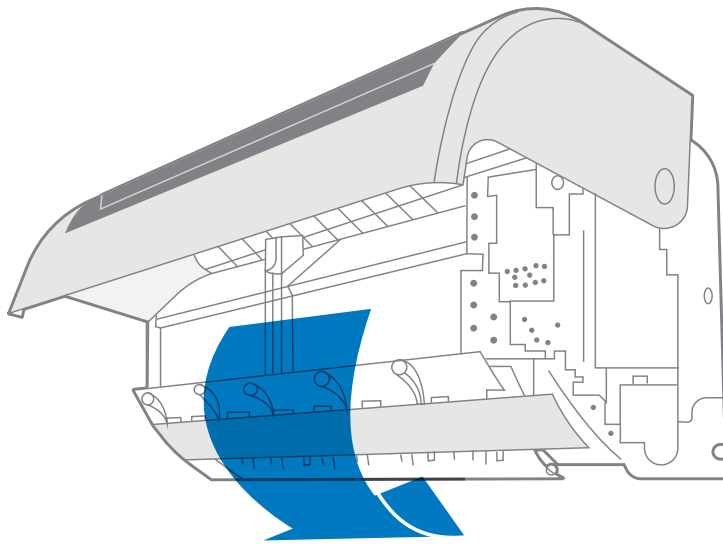
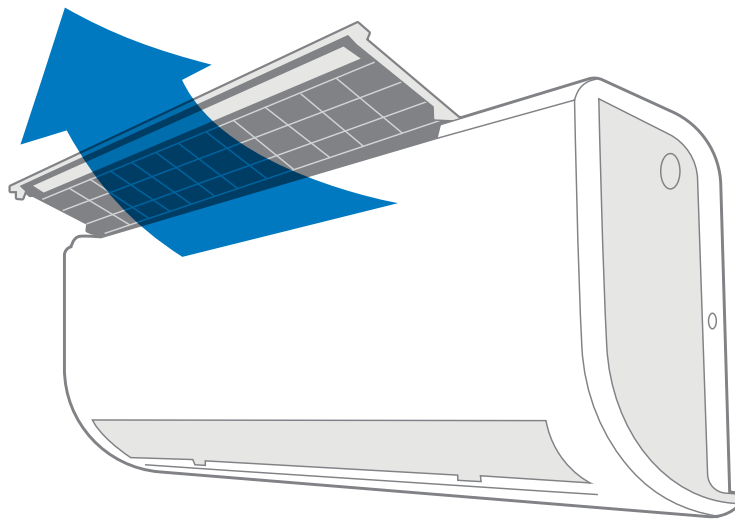

# MULTI-ZONE



**DLCMRA Outdoor Unit**

Up to 20.5 SEER

Sizes: 18 / 27 / 36 / 48



# A MULTI-ZONE OUTDOOR UNIT FOR FLEXIBILITY & CONTROL

## OUTDOOR FEATURES

- Available in 208/230V
- Connect 2-5, multiple style indoor units
- Built-in basepan heater
- Quiet outdoor operation, as low as 62 dB(A)
- Anti-corrosive fin coating
- Total piping length  
131 ~ 328 ft. (40 ~ 100 m.)
- Vertical lift/drop piping length  
49 ~ 65 ft. (15 ~ 20 m.)
- Cooling operating range  
-13° ~ 122° F (-25° ~ 50° C)
- Heating operating range  
-22° ~ 86° F (-30° ~ 30° C)

## COMPATIBLE WITH:

- DLFPHA High Wall (p 15)
- DLFSHB High Wall (p 23)
- DLFEHA High Wall (p 37)
- DLFSCA Cassette (p 25)
- DLFSDA Ducted (p 27)
- DLFSFA Console (p 29)
- DLFSAA Air Handler (p 31)

## Heat Pump with Basepan Heater

Inverter Compressor

Up to 20.5 SEER

Up to 10.8 HSPF

Sizes: 18 / 27 / 36 / 48

Select systems are ENERGY STAR® certified based on indoor combinations



## KEY FEATURES

### Space Saving Installation

Up to five indoor units can be connected to a single outdoor unit, reducing the number of outdoor units required. All indoor units can be individually controlled and do not need to be installed at the same time.

### Multiple Indoor Unit Styles

Flexibility on the options of indoor unit styles to fit any application or need.

**Note:** Multi-zone units cannot heat and cool simultaneously.



**PERFORMANCE:**

Non-Ducted								
Size	18		27		36		48	
Outdoor Model	DLCMRAH18BAK		DLCMRAH27CAK		DLCMRAH36DAK		DLCMRAH48EAK	
Max Number of Zones	2		3		4		5	
ENERGY STAR®	YES		NO		NO		NO	
Cooling System Tons	1.4		2.3		3.0		4.0	
Cooling Rated Capacity	Btu/h	17,000	27,000		36,000		48,000	
Cooling Cap. Range Min - Max	Btu/h	5,810~21,940	7,880~33,510		8,090~41,470		8,560~53,160	
SEER	21.1		20.4		21.4		20.5	
EER	12.5		11.5		10.5		11	
Heating Rated Capacity (47° F)	Btu/h	18,000	27,000		36,000		48,000	
Heating Maximum Capacity (5° F)	Btu/h	13,800	22,700		26,200		37,900	
Heating Cap. Range Min - Max	Btu/h	5,760~24,480	6,010~36,180		6,350~41,950		7,210~55,820	
HSPF	9.7		10.8		10.2		10.2	
COP (47° F)	W/W	3.5	4.0		3.7		3.5	
COP (5° F)	W/W	2.7	3.4		2.7		2.8	

**PERFORMANCE:**

Combination and Non-Ducted								
Size	18		27		36		48	
Outdoor Model	DLCMRAH18BAK		DLCMRAH27CAK		DLCMRAH36DAK		DLCMRAH48EAK	
Max Number of Zones	2		3		4		5	
Cooling System Tons	1.5		2.3		3.0		4.0	
Cooling Rated Capacity	Btu/h	17,500	27,000		36,000		48,000	
Cooling Cap. Range Min - Max	Btu/h	5,795~20,708	7,765~31,955		8,060~39,990		8,510~52,580	
SEER	19.8		19.5		19.7		19.1	
EER	12.2		11.3		10.3		10.6	
Heating Rated Capacity (47° F)	Btu/h	18,250	27,000		36,000		49,000	
Heating Maximum Capacity (5° F)	Btu/h	14,100	21,850		27,300		37,350	
Heating Cap. Range Min - Max	Btu/h	5,650~24,365	5,980~36,190		6,275~42,305		7,045~54,935	
HSPF	9.6		9.9		10.0		10.2	
COP (47° F)	W/W	3.7	3.8		3.5		3.5	
COP (5° F)	W/W	2.4	3.0		2.6		2.3	

**PERFORMANCE:**

Ducted								
Size	18		27		36		48	
Outdoor Model	DLCMRAH18BAK		DLCMRAH27CAK		DLCMRAH36DAK		DLCMRAH48EAK	
Max Number of Zones	2		3		4		5	
ENERGY STAR®	NO		NO		NO		NO	
Cooling System Tons	1.5		2.3		3.0		4.0	
Cooling Rated Capacity	Btu/h	18,000	27,000		36,000		48,000	
Cooling Cap. Range Min - Max	Btu/h	5,780~19,476	7,650~30,400		8,030~38,510		8,460~52,000	
SEER	18.4		18.5		17.9		17.6	
EER	11.8		11.0		10.0		10.1	
Heating Rated Capacity (47° F)	Btu/h	18,500	27,000		36,000		50,000	
Heating Maximum Capacity (5° F)	Btu/h	14,400	21,000		28,400		36,800	
Heating Cap. Range Min - Max	Btu/h	5,539~24,249	5,950~36,200		6,200~42,660		6,880~54,050	
HSPF	9.4		9.0		9.7		10.1	
COP (47° F)	W/W	3.8	3.5		3.2		3.4	
COP (5° F)	W/W	2.1	2.7		2.5		1.8	

# QUIETCOMFORT SERIES

## DLCMRA OUTDOOR UNIT

### SPECIFICATIONS:

DLCMRA Outdoor Unit					
Heat Pump					
System					
Size		18	27	36	48
Outdoor Model		DLCMRAH18BAK	DLCMRAH27CAK	DLCMRAH36DAK	DLCMRAH48EAK
Max Number of Zones		2	3	4	5
Operating Range					
Cooling Outdoor DB Min - Max	° F (° C)	-13~122 (-25~50)	-13~122 (-25~50)	-13~122 (-25~50)	-13~122 (-25~50)
Heating Outdoor DB Min - Max	° F (° C)	-22~86 (-30~30)	-22~86 (-30~30)	-22~86 (-30~30)	-22~86 (-30~30)
Piping					
Total Piping Length	ft (m)	131 (40)	197 (60)	263 (80)	328 (100)
Piping to furthest FCU	ft (m)	82 (25)	98 (30)	115 (35)	115 (35)
Drop (OD above ID)	ft (m)	49 (15)	49 (15)	49 (15)	65 (20)
Lift (OD below ID)	ft (m)	49 (15)	49 (15)	49 (15)	65 (20)
Pipe Connection Size - Liquid	in (mm)	"1/4*2 (6.35*2)"	"1/4*3 (6.35*3)"	"1/4*4 (6.35*4)"	"1/4*5 (6.35*5)"
Pipe Connection Size - Suction	in (mm)	"3/8*2 (9.52*2)"	"3/8*3 (9.52*3)"	"1/2 *1+ 3/8*3 (12.7*1+9.52*3)"	"1/2 *2+ 3/8*3 (12.7*2+9.52*3)"
Refrigerant					
Type		R410A	R410A	R410A	R410A
Charge	lbs (kg)	4.41 (2.0)	6.17 (2.8)	6.61 (3.0)	10.13 (4.6)
Electrical					
Voltage-Phase-Cycle	V-Ph-Hz	208/230-1-60	208/230-1-60	208/230-1-60	208/230-1-60
Power Supply		Indoor Unit Powered From Outdoor Unit			
MCA	A.	18	25	30	35
MOCP - Fuse Rating	A.	25	35	45	50
Compressor					
Type		Rotary Inverter	Rotary Inverter	Rotary Inverter	Rotary Inverter
Outdoor					
Unit Width	in (mm)	37.31 (948)	41.22 (1047)	41.22 (1047)	41.15 (1045)
Unit Height	in (mm)	27.64 (702)	31.88 (810)	31.88 (810)	52.48 (1333)
Unit Depth	in (mm)	14.82 (376)	17.91 (455)	17.91 (455)	17.63 (448)
Net Weight	lbs (kg)	105.8 (48)	149.9 (68)	156.5 (71)	223.8 (101.5)
Airflow	CFM	1,390	2,130	2,130	4,500
Sound Pressure	dB(A)	62	63	62	64

### COMPATIBILITY:

Indoor Unit		Outdoor Unit			
		DLCMRAH18BAK	DLCMRAH27CAK	DLCMRAH36DAK	DLCMRAH48EAK
DLFPHA High Wall	DLFPHAH09XAK	•	•	•	•
	DLFPHAH12XAK	•	•	•	•
DLFSHB High Wall	DLFSHBH06XAK	•	•	•	•
	DLFSHBH09XAK	•	•	•	•
	DLFSHBH12XAK	•	•	•	•
	DLFSHBH18XAK		•	•	•
	DLFSHBH24XAK			•	•
DLFEHA High Wall	DLFEHAH09XAK	•	•	•	•
	DLFEHAH12XAK	•	•	•	•
	DLFEHAH18XAK		•	•	•
	DLFEHAH24XAK			•	•
DLFSCA Cassette	DLFSCAH09XAK	•	•	•	•
	DLFSCAH12XAK	•	•	•	•
	DLFSCAH18XAK		•	•	•
	DLFSCAH24XAK			•	•
DLFSDA Ducted	DLFSDAH09XAK	•	•	•	•
	DLFSDAH12XAK	•	•	•	•
	DLFSDAH18XAK		•	•	•
	DLFSDAH24XAK			•	•
DLFSFA Console	DLFSFAH12XAK	•	•	•	•
	DLFSFAH18XAK		•	•	•
	DLFSFAH24XAK			•	•
DLFSAA Air Handler	DLFSAAH24XAK			•	•





# QUIETCOMFORT SERIES

## DLCMRA OUTDOOR UNIT

### RATED COMBINATIONS:

Heat Pump								
Outdoor Unit Model	2-Zone		3-Zone		4-Zone		5-Zone	
DLCMRAH18BAK	6+6	9+9						
	6+9	9+12						
	6+12	12+12						
DLCMRAH27CAK	6+6	9+12	6+6+6	6+9+18				
	6+9	9+18	6+6+9	6+12+12				
	6+12	12+12	6+6+12	6+12+18				
	6+18	12+18	6+6+18	9+9+9				
	9+9	18+18	6+9+9	9+9+12				
			6+9+12	9+9+18				
DLCMRAH36DAK	6+9	9+18	6+6+12	9+9+9	6+6+6+6	6+9+9+12		
	6+12	9+24	6+6+18	9+9+12	6+6+6+9	6+9+9+18		
	6+18	12+12	6+6+24	9+9+18	6+6+6+12	6+9+9+24		
	6+24	12+18	6+9+9	9+9+24	6+6+6+18	6+9+12+12		
	9+9	12+24	6+9+12	9+12+12	6+6+6+24	6+9+12+18		
	9+12	18+18	6+9+18	9+12+18	6+6+9+9	6+12+12+12		
			6+9+24	9+12+24	6+6+9+12	6+12+12+18		
			6+12+18	9+18+18	6+6+9+18	9+9+9+9		
			6+12+18	12+12+12	6+6+9+24	9+9+9+12		
			6+12+24	12+12+18	6+6+12+12	9+9+9+18		
			6+18+18	12+18+18	6+6+12+18	9+9+12+12		
			6+18+24	12+12+24	6+6+12+24	9+9+12+18		
					6+9+9+9	9+12+12+12		
						12+12+12+12		
DLCMRAH48EAK	6+18	12+18	6+6+24	9+12+18	6+6+6+18	6+12+12+24	6+6+6+6+9	6+6+9+18+24
	6+24	12+24	6+9+24	9+12+24	6+6+6+24	6+12+18+18	6+6+6+6+12	6+6+12+12+12
	9+18	18+18	6+12+18	9+18+18	6+6+9+18	6+12+18+24	6+6+6+6+18	6+6+12+12+18
	9+24	18+24	6+12+24	9+18+24	6+6+9+24	9+9+9+9	6+6+6+6+24	6+6+12+12+24
	12+12	24+24	6+18+18	9+24+24	6+6+12+12	9+9+9+12	6+6+6+9+9	6+6+12+18+18
			6+18+24	12+12+12	6+6+12+18	9+9+9+18	6+6+6+9+12	6+9+9+9+9
			6+24+24	12+12+18	6+6+12+24	9+9+9+24	6+6+6+9+18	6+9+9+9+12
			9+9+9	12+12+24	6+6+18+18	9+9+12+12	6+6+6+9+24	6+9+9+9+18
			9+9+12	12+18+18	6+6+18+24	9+9+12+18	6+6+6+12+12	6+9+9+9+24
			9+9+18	12+18+24	6+6+24+24	9+9+12+24	6+6+6+12+18	6+9+9+12+12
			9+9+24	12+24+24	6+9+9+12	9+9+18+18	6+6+6+12+24	6+9+9+12+18
			9+12+12	18+18+18	6+9+9+18	9+9+18+24	6+6+6+18+18	6+9+9+12+24
				18+18+24	6+9+9+24	9+12+12+12	6+6+6+18+24	6+9+9+18+18
					6+9+12+12	9+12+12+18	6+6+9+9+9	6+9+12+12+12
					6+9+12+18	9+12+12+24	6+6+9+9+12	6+9+12+12+18
					6+9+12+24	9+12+18+18	6+6+9+9+18	6+9+12+12+24
					6+9+18+18	9+18+18+18	6+6+9+9+24	6+12+12+12+12
					6+9+18+24	12+12+12+12	6+6+9+12+12	6+12+12+12+18
					6+12+12+12	12+12+12+18	6+6+9+12+18	9+9+9+9+9
					6+12+12+18	12+12+12+24	6+6+9+12+24	9+9+9+9+12
						12+12+18+18	6+6+9+18+18	9+9+9+9+18
								9+9+9+9+24
								9+9+9+12+12
								9+9+9+12+18
							9+9+12+12+12	
							9+9+12+12+18	
							9+12+12+12+12	
							9+12+12+12+18	
							12+12+12+12+12	

Manufacturer reserves the right to discontinue, or change at any time, specification or designs without notice or incurring obligations.

# **SINGLE ZONE LIGHT COMMERCIAL**



**DLCLRA Outdoor Unit**  
Up to 18.0 SEER  
Size: 58



**DLCLRB Outdoor Unit**  
Up to 16.5 SEER  
Sizes: 36 / 48



**DLFLCA Cassette**  
Sizes: 36 / 48



**DLFLDA Ducted**  
Sizes: 36 / 48 / 58



**DLFLFA Console**  
Sizes: 36 / 48 / 58



**DLFLAA Air Handler**  
Sizes: 36 / 48



# A LIGHT COMMERCIAL OUTDOOR UNIT FOR IMPROVED PERFORMANCE

## OUTDOOR FEATURES

- Available in 208/230V
- Built-in basepan heater
- Condenser high-temperature protection
- Refrigerant leakage detection
- Quiet outdoor operation, as low as 62.5 dB(A)
- Anti-corrosive fin coating
- Piping length 213 ft. (65 m.)
- Cooling operating range -13° ~ 122° F (-25° ~ 50° C)
- Heating operating range -22° ~ 86° F (-30° ~ 30° C)

## COMPATIBLE WITH:

- DLFLCA Cassette (p 57)
- DLFLDA Ducted (p 59)
- DLFLFA Console (p 61)

## Heat Pump with Basepan Heater

Inverter Compressor

Up to 18.0 SEER

Up to 11.5 HSPF

Size: 58

## KEY FEATURES

### Longer Piping Lengths

Piping flexibility up to a total piping length of 213 ft. (65 m.).

### Low Ambient Cooling Kit

With a built-in Low Ambient Cooling Kit or specially designed PCB, outdoor fan speeds can be changed automatically based on the temperature. The unit can run cooling operation even in low ambient temperatures.



**SPECIFICATIONS:**

DLCLRA Outdoor Unit		
Heat Pump		
System		
Size		58
Outdoor Model		DLCLRAH58AAK
Electrical		
Voltage-Phase-Cycle	V-Ph-Hz	208/230-1-60
MCA	A.	35
MOCP - Fuse Rating	A.	50
Operating Range		
Cooling Outdoor DB Min - Max	° F (° C)	-13~122 (-25~50)
Heating Outdoor DB Min - Max	° F (° C)	-22~86 (-30~30)
Piping		
Total Piping Length	ft (m)	213 (65)
Piping Lift*	ft (m)	98 (30)
Pipe Connection Size - Liquid	in (mm)	3/8 (9.52)
Pipe Connection Size - Suction	in (mm)	3/4 (19)
Refrigerant		
Type		R410A
Charge	lbs (kg)	10.19 (4.62)
Outdoor		
Unit Width	in (mm)	37.48 (952)
Unit Height	in (mm)	52.48 (1333)
Unit Depth	in (mm)	16.34 (415)
Net Weight	lbs (kg)	225.09 (102.1)
Airflow	CFM	4,415
Sound Pressure	dB(A)	64.0

\*Condensing unit above or below indoor unit.

**PERFORMANCE:**

DLFLFA Console		
Indoor Model		DLFLFAH58XAK
ENERGY STAR®		NO
Cooling System Tons		4.5
Cooling Rated Capacity	Btu/h	54,000
Cooling Cap. Range Min - Max	Btu/h	18,000-58,000
SEER		18.0
EER		9.8
Heating Rated Capacity (47° F)	Btu/h	60,000
Heating Rated Capacity (17° F)	Btu/h	39,000
Heating Capacity (5° F)	Btu/h	35,000
Heating Cap. Range Min - Max	Btu/h	12,000-63,000
HSPF		10.5
COP (47° F)	W/W	3.6
COP (17° F)	W/W	2.62
COP (5° F)	W/W	1.91

**COMPATIBILITY:**

Indoor Unit		DLCLRAH58AAK
DLFLDA Ducted	DLFLDAH58XAK	•
DLFLFA Console	DLFLFAH58XAK	•

**PERFORMANCE:**

DLFLDA Ducted		
Indoor Model		DLFLDAH58XAK
ENERGY STAR®		NO
Cooling System Tons		4.8
Cooling Rated Capacity	Btu/h	57,000
Cooling Cap. Range Min - Max	Btu/h	18,000~58,000
SEER		18.0
EER		10.0
Heating Rated Capacity (47° F)	Btu/h	62,000
Heating Rated Capacity (17° F)	Btu/h	37,600
Heating Maximum Capacity (5° F)	Btu/h	35,000
Heating Cap. Range Min - Max	Btu/h	12,000~63,000
HSPF		9.0
COP (47° F)	W/W	3.6
COP (17° F)	W/W	2.62
COP (5° F)	W/W	1.91

Manufacturer reserves the right to discontinue, or change at any time, specification or designs without notice or incurring obligations.



# GREATER FLEXIBILITY FOR IMPROVED PERFORMANCE

## OUTDOOR FEATURES

- Built-in basepan heater
- Condenser high-temperature protection
- Refrigerant leakage detection
- Quiet outdoor operation
- Anti-corrosive fin coating
- Piping length 213 ft. (65 m.)
- Cooling operating range -13° ~ 122° F (-25° ~ 50° C)
- Heating operating range -22° ~ 86° F (-30° ~ 30° C)

## COMPATIBLE WITH:

- DLFLAA Air Handler (p 63)
- DLFSCA Cassette (p 57)
- DLFLDA Ducted (p 59)
- DLFLFA Console (p 61)

## Heat Pump with Basepan Heater

Inverter Compressor

Up to 16.5 SEER

Up to 10.4 HSPF

Sizes: 36 / 48

## KEY FEATURES

### Flexible Installation

Piping flexibility up to a total piping length of 213 ft. (65 m.).

### Low Ambient Cooling

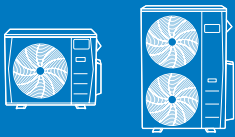

**SPECIFICATIONS:**

DLCLRB Outdoor Unit			
Heat Pump			
System			
Size		36	48
Outdoor Model		DLCLRBH36AAK	DLCLRBH48AAK
Electrical			
Voltage-Phase-Cycle	V-Ph-Hz	208/230-1-60	208/230-1-60
MCA	A.	30	36.5
MOCP - Fuse Rating	A.	45	50
Operating Range			
Cooling Outdoor DB Min - Max	° F (° C)	-13~122 (-25~50)	-13~122 (-25~50)
Heating Outdoor DB Min - Max	° F (° C)	-22~86 (-30~30)	-22~86 (-30~30)
Piping			
Total Piping Length	ft (m)	213 (65)	213 (65)
Piping Lift*	ft (m)	98 (30)	98 (30)
Pipe Connection Size - Liquid	in (mm)	3/8 (9.52)	3/8 (9.52)
Pipe Connection Size - Suction	in (mm)	5/8 (16)	5/8 (16)
Refrigerant			
Type		R410A	R410A
Charge	lbs (kg)	7.05 (3.2)	9.92 (4.5)
Compressor			
Type		Rotary Inverter	Rotary Inverter
Outdoor			
Unit Width	in (mm)	41.1 (1,045)	40.5 (1,030)
Unit Height	in (mm)	31.9 (810)	52.4 (1,333)
Unit Depth	in (mm)	17.9 (455)	17.6 (448)
Net Weight	lbs (kg)	155.42 (70.5)	219.14 (99.4)
Airflow	CFM	2,118	4,500
Sound Pressure	dB(A)	61.7	62.9

\*Condensing unit above or below indoor unit.

**COMPATIBILITY:**

Indoor Unit		Outdoor Unit	
		DLCLRBH36AAK	DLCLRBH48AAK
Ducted	DLFLDAH36XAK	•	
	DLFLDAH48XAK		•
Air Handler	DLFLAAH36XAK	•	
	DLFLAAH48XAK		•
Console	DLFLFAH36XAK	•	
	DLFLFAH48XAK		•
Cassette	DLFLCAH36XAK	•	
	DLFLCAH48XAK		•

### PERFORMANCE:

DLFSCA Cassette			
Indoor Model		DLFLCAH36XAK	DLFLCAH48XAK
ENERGY STAR®		NO	NO
Cooling System Tons		3.0	4.0
Cooling Rated Capacity	Btu/h	36,000	48,000
Cooling Cap. Range Min - Max	Btu/h	7,500~52,200	14,300~70,000
SEER		17.60	17.00
EER		9.00	9.50
Heating Rated Capacity (47° F)	Btu/h	38,000	50,000
Heating Rated Capacity (17° F)	Btu/h	22,000	29,000
Heating Capacity (5° F)	Btu/h	32,200	37,400
Heating Cap. Range Min - Max	Btu/h	12,600~55,800	15,200~59,600
HSPF		10.6	11.0
COP (47° F)	W/W	3.01	3.10
COP (17° F)	W/W	2.49	2.50
COP (5° F)	W/W	2.41	2.45

### PERFORMANCE:

DLFLDA Ducted			
Indoor Model		DLFLDAH36XAK	DLFLDAH48XAK
ENERGY STAR®		NO	NO
Cooling System Tons		3.0	4.0
Cooling Rated Capacity	Btu/h	36,000	48,000
Cooling Cap. Range Min - Max	Btu/h	7,500~52,100	15,700~76,700
SEER		16.7	17.4
EER		9	9.2
Heating Rated Capacity (47° F)	Btu/h	40,000	50,000
Heating Rated Capacity (17° F)	Btu/h	27,000	29,000
Heating Capacity (5° F)	Btu/h	29,100	39,900
Heating Cap. Range Min - Max	Btu/h	11,400~50,500	20,200~63,600
HSPF		11.5	10.3
COP (47° F)	W/W	3.37	3
COP (17° F)	W/W	2.6	2.5
COP (5° F)	W/W	2.5	2.19



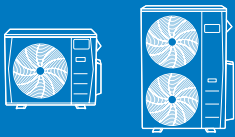

**PERFORMANCE:**

DLFLFA Console			
Indoor Model		DLFLFAH36XAK	DLFLFAH48XAK
ENERGY STAR®		NO	NO
Cooling System Tons		3.0	4.0
Cooling Rated Capacity	Btu/h	36,000	48,000
Cooling Cap. Range Min - Max	Btu/h	7,500~52,100	15,000~73,600
SEER		17	18
EER		8	9.3
Heating Rated Capacity (47° F)	Btu/h	38,000	50,000
Heating Rated Capacity (17° F)	Btu/h	22,000	29,000
Heating Capacity (5° F)	Btu/h	29,300	42,700
Heating Cap. Range Min - Max	Btu/h	11,400~50,000	17,400~68,000
HSPF		10.0	11.0
COP (47° F)	W/W	2.8	2.5
COP (17° F)	W/W	2.3	2.3
COP (5° F)	W/W	2.05	2.48

**PERFORMANCE:**

DLFLAA Air Handler			
Indoor Model		DLFLAAH36XAK	DLFLAAH48XAK
Outdoor Model		DLCLRBH36AAK	DLCLRBH48AAK
ENERGY STAR®		NO	NO
Cooling System Tons		3.0	4.0
Cooling Rated Capacity	Btu/h	36,000	48,000
Cooling Cap. Range Min - Max	Btu/h	7,500~52,000	14,300~70,000
SEER		16.5	16.0
EER		8.5	8.2
Heating Rated Capacity (47° F)	Btu/h	39,000	55,000
Heating Rated Capacity (17° F)	Btu/h	25,000	36,000
Heating Capacity (5° F)	Btu/h	25,800	31,500
Heating Cap. Range Min - Max	Btu/h	11,800~45,400	15,200~62,700
HSPF		10.4	9.5
COP (47° F)	W/W	3.2	2.6
COP (17° F)	W/W	2.45	2.3
COP (5° F)	W/W	2.3	2.08



# OPTIMAL AIR DISTRIBUTION & LIGHT COMMERCIAL COMFORT CONTROL

## INDOOR FEATURES

- Available in 208/230V
- Up to 17.5 SEER and 11.0 HSPF when paired with DLCLRA outdoor unit
- Modes: Cool, Heat, Dry, Fan, Auto
- Auto-restart function
- Louver control (fixed or swing)
- Three fan speeds
- Outside air intake
- Built-in condensate lift pump
- Follow Me (senses temperature at handheld remote)
- Heating Setback (46° F Heating Mode)
- Quiet indoor operation, as low as 49 dB(A)
- Anti-corrosive fin coating
- Grille/ceiling panel 3' x 3' KSALG0201AAA

## COMPATIBLE WITH:

- DLCLRA Outdoor Unit Single Zone

(p 51)

Sizes: 36 / 48

## KEY FEATURES

### Built-In Condensate Lift Pump

The cassette is supplied with a condensate lift pump that is capable of lifting the water 29.5 in. (750 mm.) above the top of the unit.

### 360° Air Flow Panel

With the 360° air flow panel, air is distributed to every corner of the room.

## CONTROLS

Wireless Remote Controller included with indoor unit

Optional Wired Remote Controller KSACN0101AAA (Timer Function)

Optional Wired Remote Controller KSACN0701AAA (7-Day Programmable)



Wireless Remote Controller



Wired Controller (7-Day Programmable) KSACN0701AAA

## ACCESSORIES

Wi-Fi® Kit KSAIF0401AAA

24V Interface for third-party thermostat compatibility KSAIC0401230



**NOTE:** Grille is required; sold separately.

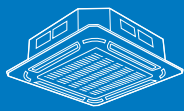

**SPECIFICATIONS:**

DLFLCA Cassette			
Heat Pump			
System			
Size		36	48
Indoor Model		DLFLCAH36XAK	DLFLCAH48XAK
Electrical			
Voltage-Phase-Cycle	V-Ph-Hz	208/230-1-60	208/230-1-60
Power Supply		Indoor Unit Powered From Outdoor Unit	
MCA	A.	0.8	1.6
Operating Range			
Cooling Indoor DB Min - Max	° F (° C)	63~90 (17~32)	63~90 (17~32)
Heating Indoor DB Min - Max	° F (° C)	32~86 (0~30)	32~86 (0~30)
Piping			
Pipe Connection Size - Liquid	in (mm)	3/8 (9.52)	3/8 (9.52)
Pipe Connection Size - Suction	in (mm)	5/8 (16)	5/8 (16)
Indoor			
Body Unit Width	in (mm)	33.07 (840)	33.07 (840)
Body Unit Height	in (mm)	9.65 (245)	11.3 (287)
Body Unit Depth	in (mm)	33.07 (840)	33.07 (840)
Body Net Weight	lbs (kg)	58.2 (26.4)	63.27 (28.7)
Panel Unit Width		37.4 (950)	37.4 (950)
Panel Unit Height	in (mm)	2.17 (55)	2.17 (55)
Panel Unit Depth	in (mm)	37.4 (950)	37.4 (950)
Panel Net Weight	lbs (kg)	11.02 (5)	11.02 (5)
Number of Fan Speeds		3	3
Airflow (lowest to highest)	CFM	809/958/1095	853/1030/1177
Sound Pressure (lowest to highest)	dB(A)	49/52/55	49/52/55
Air Throw Data	ft (m)	30 (9)	30 (9)
Moisture Removal	Pint/h (L/h)	8.53 (4.04)	13.5 (6.39)
Field Drain Pipe Size O.D.	in (mm)	1 (25.4)	1 (25.4)

**COMPATIBILITY:**

Indoor Unit	DLFLCAH36XAK	DLFLCAH48XAK
Outdoor Unit Single Zone*	DLCLRAH36AAK	DLCLRAH48AAK

\*Performance may vary based on the compatible outdoor units. See respective pages for performance data.



# MAXIMUM FLEXIBILITY & LIGHT COMMERCIAL PERFORMANCE

## INDOOR FEATURES

- Available in 208/230V
- Up to 18.0 SEER and 11.5 HSPF when paired with DLCLRA outdoor unit
- Modes: Cool, Heat, Dry, Fan, Auto
- Vertical (sizes 36 & 48) or horizontal installation
- Up to 0.8 in W.C.
- Rear or bottom return (sizes 36 & 48)
- Constant CFM operation on sizes 36 & 48 only
- Built-in condensate lift pump
- Follow Me (senses temperature at handheld remote)
- Heating Setback (46° F Heating Mode)
- Quiet indoor operation, as low as 38.5 dB(A)
- Anti-corrosive fin coating

## COMPATIBLE WITH:

- DLCLRA Outdoor Unit Single Zone (p 51)

Sizes: 36 / 48 / 58

## KEY FEATURES

### Vertical or Horizontal Installation

Designed for maximum installation flexibility with the built-in secondary drain pan, which allows the unit to be mounted vertically for either a floor- or ceiling-concealed installation depending on existing conditions for sizes 36 and 48 only.

### Built-In Condensate Lift Pump

Supplied with a condensate lift pump that is capable of lifting the water 29.5 in. (750 mm.) above the top of the unit.

## CONTROLS

Wireless Remote Controller included with indoor unit  
 Wired Remote Controller (7-Day Programmable) included with indoor unit



Wireless Remote Controller



Wired Controller (7-Day Programmable) KSACN0701AAA

## ACCESSORIES

Wi-Fi® Kit KSAIF0401AAA

24V Interface for third-party thermostat compatibility KSAIC0401230





**SPECIFICATIONS:**

<b>DLFLDA Ducted</b>				
<b>Heat Pump</b>				
<b>System</b>				
Size		36	48	58
Indoor Model		DLFLDAH36XAK	DLFLDAH48XAK	DLFLDAH58XAK
<b>Electrical</b>				
Voltage-Phase-Cycle	V-Ph-Hz	208/230-1-60	208/230-1-60	208/230-1-60
Power Supply		Indoor Unit Powered From Outdoor Unit		
MCA	A.	2.45	3.2	3.65
<b>Operating Range</b>				
Cooling Indoor DB Min - Max	° F (° C)	63~90 (17~32)	63~90 (17~32)	63~90 (17~32)
Heating Indoor DB Min - Max	° F (° C)	32~86 (0~30)	32~86 (0~30)	32~86 (0~30)
<b>Piping</b>				
Pipe Connection Size - Liquid	in (mm)	3/8 (9.52)	3/8 (9.52)	3/8 (9.52)
Pipe Connection Size - Suction	in (mm)	5/8 (16)	5/8 (16)	3/4 (19)
<b>Indoor</b>				
Unit Width	in (mm)	53.54 (1360)	47.24 (1200)	55.12 (1400)
Unit Height	in (mm)	9.8 (249)	11.81 (300)	17.32 (440)
Unit Depth	in (mm)	30.47 (774)	34.41 (874)	33.78 (858)
Net Weight	lbs (kg)	106.48 (48.3)	119.71 (54.3)	163 (74)
Number of Fan Speeds		3	3	3
Airflow (lowest to highest)	CFM	700/910/1080	720/1030/1230	1260/1710/2150
Sound Pressure (lowest to highest)	dB(A)	38.5/42/45.5	46/49.5/50.5	51/54/57
Max. Static Pressure	in (W.C.)	0.64	0.64	0.80
Field Drain Pipe Size O.D.	in (mm)	1 (25.4)	1 (25.4)	1 (25.4)

**COMPATIBILITY:**

Indoor Unit	DLFLDAH36XAK	DLFLDAH48XAK	DLFLDAH58XAK
Outdoor Unit Single Zone*	DLCLRAH36AAK	DLCLRAH48AAK	DLCLRAH58AAK

\*Performance may vary based on the compatible outdoor units. See respective pages for performance data.



# EASY LIGHT COMMERCIAL INSTALLATION & QUIET OPERATION

## INDOOR FEATURES

- Available in 208/230V
- Up to 18.0 SEER and 11.0 HSPF when paired with DLCLRA outdoor unit
- Modes: Cool, Heat, Dry, Fan, Auto
- Auto-restart function
- Can be mounted on floor or ceiling
- Louver control (fixed or swing)
- Three fan speeds
- Follow Me (senses temperature at handheld remote)
- Heating Setback (46° F Heating Mode)
- Quiet indoor operation, as low as 43 dB(A)
- Anti-corrosive fin coating

## COMPATIBLE WITH:

- DLCLRA Outdoor Unit Single Zone

(p 51)

Sizes: 36 / 48 / 58

## KEY FEATURES

### Outside Air Intake

Outside air can be brought into the room through the connection available on the indoor unit, which helps meet the ventilation air requirements.

### Flexible Installation

Can be installed on the floor or ceiling depending on the application.

## CONTROLS

Wireless Remote Controller included with indoor unit

Optional Wired Remote Controller KSACN0101AAA (Timer Function)

Optional Wired Remote Controller KSACN0701AAA (7-Day Programmable)



Wireless  
Remote Controller



Wired Controller  
(7-Day Programmable)  
KSACN0701AAA

## ACCESSORIES

Wi-Fi® Kit KSAIF0401AAA

24V Interface for third-party thermostat compatibility KSAIC0401230





**SPECIFICATIONS:**

DLFLFA Console				
Heat Pump				
System				
Size		36	48	58
Indoor Model		DLFLFAH36XAK	DLFLFAH48XAK	DLFLFAH58XAK
Electrical				
Voltage-Phase-Cycle	V-Ph-Hz	208/230-1-60	208/230-1-60	208/230-1-60
Power Supply		Indoor Unit Powered From Outdoor Unit		
MCA	A.	1.23	0.85	1.48
Operating Range				
Cooling Indoor DB Min - Max	° F (° C)	63~90 (17~32)	63~90 (17~32)	63~90 (17~32)
Heating Indoor DB Min - Max	° F (° C)	32~86 (0~30)	32~86 (0~30)	32~86 (0~30)
Piping				
Pipe Connection Size - Liquid	in (mm)	3/8 (9.52)	3/8 (9.52)	3/8 (9.52)
Pipe Connection Size - Suction	in (mm)	5/8 (16)	5/8 (16)	5/8 (16)
Indoor				
Unit Width	in (mm)	50.59 (1285)	64.96 (1650)	64.96 (1650)
Unit Height	in (mm)	9.25 (235)	9.25 (235)	9.25 (235)
Unit Depth	in (mm)	26.57 (675)	26.57 (675)	26.57 (675)
Net Weight	lbs (kg)	69 (31.3)	83.78 (38)	110 (50)
Number of Fan Speeds		3	3	3
Airflow (lowest to highest)	CFM	638/917/1037	1000/1120/1350	796/1029/1385
Sound Pressure (lowest to highest)	dB(A)	43/49/54	52/54/57	46/49/55
Air Throw Data	ft (m)	33(10)	39(12)	39(12)
Field Drain Pipe Size O.D.	in (mm)	1 (25.4)	1 (25.4)	1 (25.4)

**COMPATIBILITY:**

Indoor Unit	DLFLFAH36XAK	DLFLFAH48XAK	DLFLFAH58XAK
Outdoor Unit Single Zone*	DLCLRAH36AAK	DLCLRAH48AAK	DLCLRAH58AAK

\*Performance may vary based on the compatible outdoor units. See respective pages for performance data.



# A MULTI-POISE AIR HANDLER FOR MAXIMUM FLEXIBILITY

## INDOOR FEATURES

- Modes: Cool, Heat, Dry, Fan, Auto
- Up to 20.0 SEER and 10.4 HSPF based on outdoor unit pairing
- Multi poise installation (Up Flow, Down Flow, Horizontal Right, Horizontal Left)
- Total system static pressure up to 0.8 in. W.C.
- Less than 2% air leakage
- Quiet indoor operation
- Built-in third-party thermostat compatibility
- Anti-corrosive fin coating
- Extreme heating operation in as low as -22° F (-30° C) based on outdoor unit pairing
- Optional Electric Heat Packages available (5, 10, 15 and 20 KW)

## COMPATIBLE WITH:

- DLCSRB Outdoor Unit Single Zone (p 19)
- DLCMRA Outdoor Unit Multi-Zone (p 45)
- DLCLRB Outdoor Unit Single Zone (p 53)

Size: 24 / 36 / 48

Select sizes are ENERGY STAR® certified based on outdoor unit pairing



## KEY FEATURES

### Installation Flexibility

A built-in secondary drain allows the unit to be mounted vertically (up flow or down flow) or horizontally (left or right), enabling multi-position installation. All three sizes are capable of operating as traditional central ducted systems when paired with a compatible single zone outdoor unit.

### Multi-Zone Compatibility

The size 24 Air Handler can connect to select multi-zone outdoor units to create one integrated system, enabling unique zoned comfort and efficiency.

### Efficient Comfort

As an alternate to gas furnaces, reduce the use of fossil fuels and experience cleaner energy and efficiency levels that meet many local and federal requirements.

## CONTROLS

Factory installed 24V interface for third-party thermostat compatibility\*

Wireless Remote Controller included

## ACCESSORIES

Electric Heat Packages EHKMA05KN, EHKMA10KN, EHKMA15KN, EHKMA20KN

Only Size 24 is available for multi-zone applications.

\*See installation instructions for details





**SPECIFICATIONS:**

DLFLAA Air Handler				
Heat Pump				
System				
Size		24	36	48
Indoor Model		DLFSAAH24XAK	DLFLAAH36XAK	DLFLAAH48XAK
Electrical				
Voltage-Phase-Cycle	V-Ph-Hz	208/230-1-60	208/230-1-60	208/230-1-60
Power Supply		Indoor Unit Powered by Outdoor Unit		
MCA	A.	5	5	5
Controls				
Wireless Remote Controller (° F/° C Convertible)		Standard	Standard	Standard
Third-Party Thermostat Compatability		Standard	Standard	Standard
Operating Range				
Cooling Indoor DB Min - Max	° F (° C)	62~90 (17~32)	62~90 (17~32)	62~90 (17~32)
Heating Indoor DB Min - Max	° F (° C)	32~86 (0~30)	32~86 (0~30)	32~86 (0~30)
Piping				
Pipe Connection Size - Liquid	in (mm)	3/8 (9.52)	3/8 (9.52)	3/8 (9.52)
Pipe Connection Size - Suction	in (mm)	5/8 (16)	5/8 (16)	5/8 (16)
Indoor				
Unit Width	in (mm)	19.6 (498)	19.6 (498)	19.6 (498)
Unit Height	in (mm)	48.8 (1,240)	48.8 (1,240)	48.8 (1,240)
Unit Depth	in (mm)	21.0 (533)	21.0 (533)	21.0 (533)
Net Weight	lbs (kg)	141.1 (64)	144.8 (65.7)	144.8 (65.7)
Number of Fan Speeds		4	4	4
Airflow (lowest to highest)	CFM	588/765/882	824/1,000/1,176	1,176/1,294/1,412
Sound Pressure - Cooling (lowest to highest)	dB(A)	37.2/40.4/43/45.2	37.2/40.4/43/45.2	37.2/40.4/43/45.2
Sound Pressure - Heating (lowest to highest)	dB(A)	35.8/38.7/41.7	37.9/43/46.5/48	50/51.9/53.9/54.9
Max Static Pressure	in. W.C.	0.80	0.80	0.80
Field Drain Pipe Size O.D.	in (mm)	3/4 (19.1)	3/4 (19.1)	3/4 (19.1)

\*Performance may vary based on the compatible outdoor units. See respective pages for performance data.

**COMPATIBILITY:**

Indoor Unit		Outdoor Unit Single Zone			Outdoor Unit Multi-Zone	
		DLCSRBH24AAK	DLCLRBH36AAK	DLCLRBH48AAK	DLCMRAH36DAK	DLCMRAH48EAK
DLFSAA Air Handler	DLFSAAH24XAK	•			•	•
DLFLAA Air Handler	DLFLAAH36XAK		•			
	DLFLAAH48XAK			•		

**Multi-Zone configuration:**

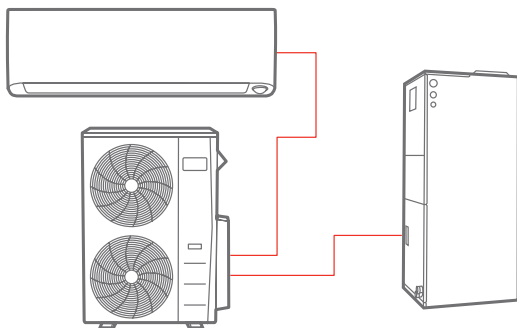

# **ACCESSORIES AND ADDITIONAL INFORMATION**

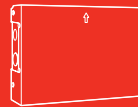

**24V Interface Kit  
for Ductless Systems**



**Wi-Fi® Kit**



# IMPROVED COMPATIBILITY FOR DUCTLESS SYSTEMS

## FEATURES

- Control the ductless system using a third-party thermostat<sup>1</sup>
- One 24V Interface Kit per indoor head<sup>2</sup>
- Keeps the Inverter compressor operating as a variable-speed system<sup>3</sup>
- Rated for outdoor and indoor mounting
- Dry mode contact for active dehumidification control
- Remote on/off contact
- Auxiliary heat control through the thermostat<sup>4</sup>
- Diagnostic code display LEDs
- Power supplied through the outdoor unit

## COMPATIBLE WITH:

- DLFPHA High Wall (p 15)
- DLFSHB High Wall (p 23)
- DLFEHA High Wall (p 39)
- DLFSCA Cassette (p 25)
- DLFLCA Cassette (p 59)
- DLFSDA Ducted (p 27)
- DLFLDA Ducted (p 61)
- DLFSFA Console (p 29)
- DLFLFA Console (p 63)

## KSAIC0401230

The Second Generation 24V Interface Kit allows both single and multi-zone ductless systems to be compatible with and controlled by any third-party, single-stage conventional thermostat.<sup>1</sup> The 24V Interface Kit maintains the benefits of variable-speed technology, enabling increased efficiency and comfort for end users.<sup>3</sup>

## KEY BENEFITS

### Maintain Inverter Compressor Technology

The new 24V Interface keeps the Inverter compressor operating as a variable-speed system when using a third-party thermostat, making adjustments to maintain more consistent operation.

### Easy & Flexible Installation

Experience quick and easy installation between either a single or multi-zone outdoor unit and the fan coil. The interface can be installed either indoors or outdoors.

### Consumer Choice & Control

Consumers can choose to use either the included Remote Controller or their preferred third-party thermostat to control each ductless unit.

## ACCESSORIES

115V Transformer RCD#11203103000393 (Used only on ductless systems with 115V power.)



**COMPATIBILITY:**

The Second Generation of the 24V Interface Kit model number KSAIC0401230 is compatible with the ductless systems listed below. Before installation, check the compatibility of your ductless system. Product must be installed by a licensed HVAC technician.

Type of Indoor Unit	Indoor Family Name	Single Zone Outdoor Family Name	Multi-Zone Outdoor Family Name	208/230V
High Wall	DLFPHA	DLCPPRA	DLCMRA	All Sizes
	DFLSHA	DLCSRB	DLCMRA	All Sizes (see Note)
	DLFEHA	DLCERB	DLCMRA	All Sizes
Cassette	DLFSCA	DLCSRB	DLCMRA	All Sizes
	DLFLCA	DLCLRA		All Sizes
Ducted	DLFSDA	DLCSRB	DLCMRA	All Sizes
	DLFLDA	DLCLRA		All Sizes Except Size 58 (See Note)
Console	DLFSFA	DLCSRB	DLCMRA	All Sizes Except Sizes 12 (See Note)
	DLFLFA	DLCLRA		All Sizes Except Size 58 (See Note)

**Note:** The Indoor unit requires an updated control board for compatibility with the 24V Interface Kit. High wall units starting with Serial # V184810001 produced after Year 2018 Week 48 are shipped with the compatible control board. For other model numbers not shown on the table above, please contact your ductless representative. Ducted size 58 and Console sizes 12 and 58 starting with Serial # V191410001 are shipped with the compatible control board.

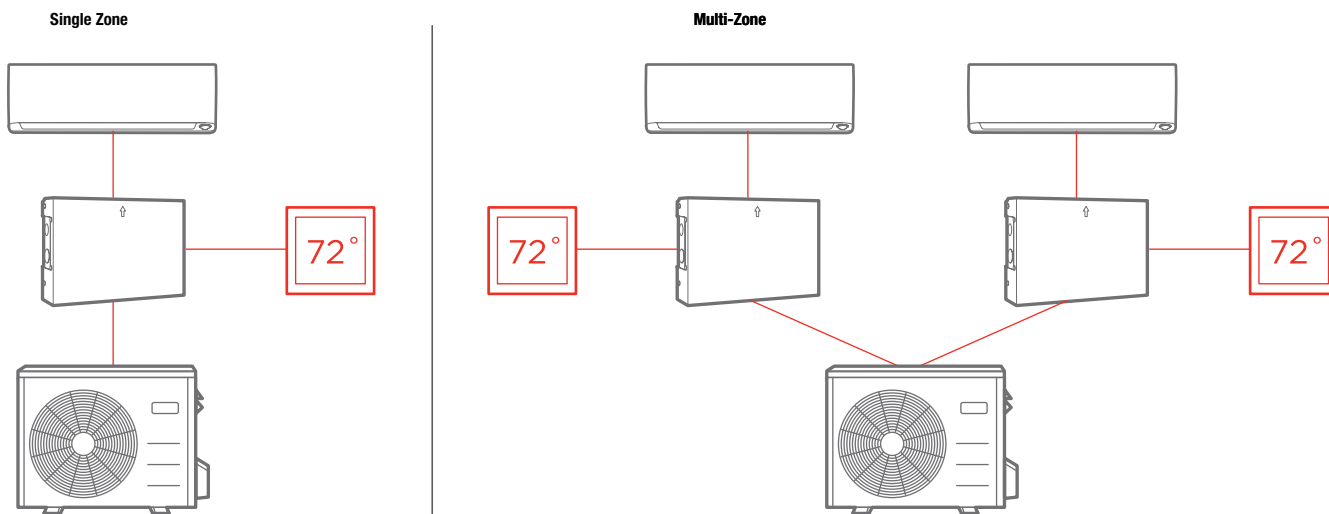

**Notes:**

<sup>1</sup>Third-party thermostats used with the 24V Interface Kit will replace the wireless Remote Controller included with the unit. Consult with dealer for more information.

<sup>2</sup>When using in a multi-zone System not all the indoor heads require a 24V Interface Kit.

<sup>3</sup>A conventional 5-wire thermostat is required.

<sup>4</sup>A secondary output is necessary for auxiliary heat control.

### SINGLE ZONE HYBRID SOLUTIONS COMPATIBILITY

Hybrid Solution with Conventional Fan Coils						
INDOOR UNIT		OUTDOOR UNIT				
		DLC SRBH12AAK	DLC SRBH18AAK	DLC SRBH24AAK	DLC SRBH30AAK	DLC SRBH36AAK
Type	Fan Coil					
FEM4 Fan Coil	FEM4P18**AL	• ‡	• ‡			
	FEM4X18**BL	• ‡	• ‡			
	FEM4P24**AL			• ‡		
	FEM4P30**AL				• ‡	
	FEM4X30**BL				• ‡	
	FEM4P36**AL					• ‡
FMA4X Fan Coil	FMA4X18**AL*	• ‡	• ‡			
	FMA4X24**AL*			• ‡		
	FMA4X30**AL*				• ‡	
	FMA4X36**AL*					• ‡
FVM4X Fan Coil	FXM4X18**AL	• ‡	• ‡			
	FXM4X24**AL			• ‡		
	FXM4X30**AL				• ‡	
	FXM4X36**AL					• ‡
FVM4X Fan Coil	FVM4X24***L	• ‡	• ‡	• ‡		
	FVM4X36***L				• ‡	• ‡
FMC - FMU Fan Coil	FM(C,U)4Z18**AL*	• ‡	• ‡			
	FM(C,U)4Z24**AL*			• ‡		
	FM(C,U)4Z30**AL*				• ‡	
	FM(C,U)4Z36**AL*					• ‡

Notes:

‡ Requires 24V interface KSAIC0401230. TXV on the indoor unit or cased coil shall be removed. 24V Transformer on the 24V interface shall be removed. Consult the installation instructions manual

Key	Multi-poise A Coil	Vertical N Coil
A	EA*4X19L17A*	
B	EA*4X24L14A*	EN(A,D)4X18L14** EN(A,D)4X24L14**
C	EA*4X24L17A*	EN(A,D)4X24L17**
D	EA*4X25L17A*	EN(A,D)4X24L17**
E	EA*4X30L14A*	EN(A,D)4X30L14**
F	EA*4X30L17A*	EN(A,D)4X30L17**
G	EA*4X36L17A*	EN(A,D,W)4X36L17**
H	EA*4X36L21A*	EN(A,D)4X36L21**
I	EA*4X37L17A*	END4X42L17**
J	EA*4X37L21A*	EN(A,D,W)4X42L21**
K	EA*4X42L21A*	EN(A,D,W)4X42L21**
L	EA*4X43L21A*	EN(A,D,W)4X42L21**

NOT AVAILABLE / COMPATIBLE

CURRENT MODELS



SINGLE ZONE HYBRID SOLUTIONS COMPATIBILITY

Hybrid Solution with Furnace / Cased Fan Coils						
INDOOR UNIT		OUTDOOR UNIT				
Type	Furnace	DLCSRBH12AAK	DLCSRBH18AAK	DLCSRBH24AAK	DLCSRBH30AAK	DLCSRBH36AAK
80% AFUE Furnace	*80ES(N,L)0451412A*	B•‡	A, B, C, D•‡	B, E•‡	E•‡	I•‡
	*80ES(N,L)0451712A*	C•‡	A, C, D•‡	G•‡	F•‡	G, I, J•‡
	*80ES(N,L)0701412A*	B•‡	A, B, C, D•‡	B, E•‡	E•‡	G•‡
	*80ES(N,L)0701712A*		C•‡	C, F, G•‡		I, J•‡
	*80ES(N,L)0701716A*	C•‡			F•‡	
	*80ES(N,L)0702116A*	H•‡			H•‡	H, J•‡
	*80ES(N,L)0901714A*					G, H, I, J•‡
	*80ES(N,L)0902116A*	H•‡			H•‡	H, J•‡
	*80ES(N,L)0902120A*					H, J•‡
	*80ES(N,L)1102120A*					H, J•‡
	*80ESU0401712A*	C•‡	A, C, D•‡	C, F, G•‡	F•‡	G, H, I, J•‡
	*80ESU0601716A			C, F, G•‡		G, H, I, J•‡
	*80ESU0802120A					H•‡
	*80ESU1002120A*					H•‡
90% AFUE Furnace	*92ESN0401410A*	B•‡	A, B, C, D•‡	B, E•‡	E•‡	
	*92ESN0401712A*		A, C•‡			
	*92ESN0601412A*	B•‡	A, B, C, D•‡	B, E•‡	E•‡	G, I•‡
	*92ESN0601714A*	C•‡		B, E•‡	F•‡	G, H•‡
	*92ESN0801716A*	C•‡	C•‡	C, F, G•‡	F•‡	G, H, I•‡
	*95ESN0261410A*	C•‡	A, B, C, D•‡	B, E•‡		
	*95ESN0401410A*	C•‡	A, B, C, D•‡	B, C, E, F, G, I•‡	E, G, I•‡	
	*95ESN0401712A*	C•‡	A, C, D•‡	C, D, F, G, H, I, J•‡	F, G, H, I, K, L•‡	
	*95ESN0601412A*	B•‡	B, C•‡	B, C, D, E, F, G, I•‡	E, F, G, I•‡	
	*95ESN0601714A*		A, C, D•‡	C, D, F, G, H, I, J•‡	F, G, H, I, J, K, L•‡	
	*95ESN0801716A*	C•‡			F•‡	
	*95ESN0802120A*	H•‡			H•‡	
	*95ESU0401712A*	C•‡	A, C, D•‡	C, F, G•‡	F•‡	
	*96VTN0401410A*	B•‡	A, B, C, D•‡	B, E•‡	E•‡	
	*96VTN0401712A*	C•‡	A, C, D•‡	C, F, G•‡	F•‡	
	*96VTN0601412A*	B•‡	A, B, C, D•‡	B, E•‡	E•‡	
	*96VTN0601714A*	C•‡	A, C, D•‡	C, F, G•‡	F•‡	G, H, I•‡
	*96VTN0801716A*	C•‡	D•‡	C, F, G•‡	F•‡	H, I, J•‡
	*96VTN0802120A*	H•‡			H•‡	H, J•‡
	*96VTN1002120A*	H•‡			H•‡	H•‡
*96VTN1002122A*					H, J•‡	

Notes:

‡ Requires 24V interface KSAIC0401230. TXV on the indoor unit or cased coil shall be removed. 24V Transformer on the 24V interface shall be removed. Consult the installation instructions manual.

Letter indicates compatible cased coil for selected combinations.

Performance ratings can be found on AHRI.

NOT AVAILABLE / COMPATIBLE

CURRENT MODELS

WI-FI® ACCESSORY KIT



# GET CLIMATE CONTROL AT YOUR FINGERTIPS WITH WI-FI® CONNECTIVITY

## FEATURES

- Multiple modes, including Turbo, Cool, Heat, Dry, Fan, Auto and ECO (on compatible indoor units)
- Multiple fan speeds
- Sleep curve
- Up-down / right-left louver control (fixed or swing) on compatible indoor units
- Heating setback (46° F heating mode)
- Timer function for on/off scheduling

Heil ductless indoor units are Wi-Fi® enabled through our Wi-Fi® Accessory Kits. Easily connect to network apps from your hand-held device for system control on the go.

## APPS

The Midea Air app is compatible with all kits and available in the App Store® for iOS devices and Google Play™ for Android devices.

## COMPATABILITY

The Wi-Fi® Accessory Kits are backwards compatible with indoor units of the same series. No serial number cutout.

Wi-Fi® Accessories Model#	Description	DLFPHA	DLFSHB	DLFSCA DLFLCA	DLFSDA DLFLDA	DLFSFA DLFLFA	DLFEHA
KSAIF0101AAA	Wi-Fi® High Wall Entry Tier 9/12/24k						•
KSAIF0201AAA	Wi-Fi® High Wall Entry Tier - 18k ONLY						•
KSAIF0401AAA	Wi-Fi® Cassettes, Ducted, Console*			•	•	•	
KSAIF0501AAA	Wi-Fi® High Wall Mid-Tier		•				
KSAIF0601AAA	Wi-Fi® High Wall High Tier	•					

\*Not available for Console size 12

**Note:** The Follow Me function is not selectable from the app, only available on the Wired or Wireless Remote Controllers (sensing temperature from the controller). If this mode is previously activated with the controller, the Follow Me functions would be deactivated if the Operation Mode is adjusted or if the unit is turned through the app.





### COMPONENTS:

All the components required for retrofit and operation are included with the Kits:

Kit Part Number	Indoor Unit Type	Components Included with Kit			
		Wi-Fi® USB Dongle	Wi-Fi® Translator PCB	USB Intermediate Cable	Display Box
KSAIF0101AAA	High Wall Entry Tier 9/12/24k	•		•	•
KSAIF0201AAA	High Wall Entry Tier 18k	•		•	•
KSAIF0401AAA	Cassette (all sizes) Ducted (all sizes) Console (only sizes 18-58)*	•	• Includes 19ft (6m) cable and Wireless Control		
KSAIF0501AAA	High Wall Mid-Tier (all sizes)	•		•	•
KSAIF0601AAA	High Wall High Tier (all sizes)	•			

The individual components included with the kits are also available through RCD for replacement.

\*Not available for Console size 09 or 12.

### COMPATIBILITY:

The use of the Wi-Fi® Accessory Kits on some indoor units would disable the ability to use the Wired Controllers in some instances:

	Wired Control	Wireless Control
High Tier High Wall	•	•
Mid-Tier High Wall		•
Entry Tier High Wall		•
Ducted	•	•
Cassette	•	•
Console 18-58	•	•

**Note:** The use of the 24V interface will disable system's Wi-Fi® module. Please consider using a Wi-Fi® Thermostat when using the 24V interface.

Wi-Fi® kits cannot be used on networks requiring a user login.

Wi-Fi® kits are only supported with networks using WPA-PSK/WPA2-PSK encryption and no encryption. WPA-PSK/WPA2-PSK encryption is recommended.

Please consult the installation instructions and Owners Manuals of the individual kits for more information.

## Dealer Support

**At Heil, we know that you work hard to uphold your reputation as a trusted dealer and expert in your market.** And that you must consistently offer innovative, efficient, high-performing products and services to keep customers happy and stay competitive.

Essentially, we know what you need to be successful and we aim to create the best experience possible for you. That's why we provide all our dealers with top-notch factory support and team up with distributors to provide the tools needed for success, including:



**Training on ductless systems**



**Dealer loyalty programs and incentives**



**A dealer locator tool to help drive leads**



**Educational and sales resources**

It's all part of our commitment to helping you succeed and offer the greatest value and support to your customers.

### NEED ASSISTANCE? WE'RE HERE FOR YOU!

**Online:** [heil.hvacpartners.com](http://heil.hvacpartners.com)

**Email:** [ductlessapplications@carrier.com](mailto:ductlessapplications@carrier.com)



Get product information, find a distributor, download technical documents.



Get technical support and information regarding parts and service.

## Model Numbers, Tiers, Warranties & Controls

### MODEL NUMBER NOMENCLATURE

Position	1	2	3	4	5	6	7	8	9	10	11	12
Description	Type Unit			Product Series	Unit Type	Major Series	Unit Type	Cooling Capacity 1,000 BTUh (nominal)	Max Number of Zones Connected to Outdoor Unit	Variations	Electrical Voltage-Phase	
Example	DLF = Fan Coil Indoor  DLC = Condensing Unit Outdoor			P = Premium (High Tier) S = Standard (Mid-Tier) E = Entry Tier M = Multi-Zone L = Light Commercial	A = Air Handler C = Cassette D = Ducted F = Console H = High Wall R = Outdoor	A = Standard  B = Next Series	A = Air Conditioner (Cooling Only)  H = Heat Pump	06 09 12 18 24 30 36 48 58	A = 1 B = 2 C = 3 D = 4 E = 5  X = Indoor Unit	A = Standard	J = 115-1  K=208/230-1	
Product Example 1: DLFPHA09XAK	DLF = Fan Coil Indoor			P = Premium (High Tier)	H = High Wall	A = Standard	H = Heat Pump	09	X = Indoor Unit	A = Standard	K=208/230-1	
Product Example 2: DLCMRAH48EAK	DLC = Condensing Unit Outdoor			M = Multi-Zone	R = Outdoor	A = Standard	H = Heat Pump	48	E = 5 Units	A = Standard	K=208/230-1	

### TIERS

Product Tier	Series Name
High Tier	Deluxe Series
Mid-Tier	QuietComfort® Series
Entry Tier	Performance Series

### WARRANTY

Application / Tier	Warranty
Residential	10 Compressor / 10 parts*
Multifamily	10 Compressor / 10 parts*
Commercial	7 Compressor / 7 Parts

\*With timely registration otherwise 5 years Compressor / 5 years parts

### CONTROLS

		Wired Controller			
		KSACN0101AAA	KSACN0601AAA	KSACN0701AAA	KSACN0901AAA
Function	Timer Function	X			
	7-Day Programmable		X	X	
High Wall	DLFPHA		◦		
	DLFSHB		◦		•
	DLFEHA		◦		
Cassette	DLFSCA		◦	◦	
Cassette	DLFLCA		◦	◦	
Ducted	DLFSDA		◦	•	
Ducted	DLFLDA		◦	•	
Console	DLFSFA		◦ Size 12	◦ Sizes 18-24	
Console	DLFLFA		◦	◦	



•	Standard
◦	Optional

## Standard Features Glossary

### 24-Hour Timer

Set the unit to start and stop automatically in a 24-hour period.

### Air Flow Panel

360° air outlet creates a soft and gentle air flow, which circulates throughout the whole space and provides an even temperature distribution in the room.

### Auto Defrosting

Prevents the evaporator from freezing and maintains dehumidifying effect in low temperature environments.

### Auto Restart Function

If the unit shuts off unexpectedly due to a power outage, it will restart with the previous settings automatically when the power resumes.

### Built-In Basepan Heater

A heating belt is fitted on the base plate of the outdoor unit to prevent water accumulation, which improves heat transfer efficiency.

### Built-In Condensate Lift Pump

A powerful, built-in drain pump can lift the condensing water up to 29 inches.

### Control Box Inside the Cassette

Easy maintenance with the box right inside the Cassette indoor unit. The integrated design provides a more compact size for easier installation.

### Convenient Temperature Controls

An intuitive, easy-to-use remote control displays temperature and other functions on a bright, clear LCD screen.

### Convertible Return Air Inlet

The air inlet can be installed either at the back or bottom of the Ducted unit, allowing for flexible installation to meet the need of each job.

### Crankcase Heater

A heating belt is fitted on the compressor to prevent frosting water accumulation, which improves heat transfer efficiency.

### Diamond Outdoor Unit Design

An innovative outdoor unit reduces noise level by more than 3 dB(A), with higher reliability, easier maintenance and improved performance.

### Eco Mode

Provides the ultimate energy savings and a comfortable sleeping environment with an intelligent eight-hour night cycle program that saves up to 60% of energy.

### Extra Low Temperature Heating

When it's cold outside, it's warm inside. High Tier and Mid-Tier Ductless Systems can be used as a primary heat source, with heat output down to -22° F.

### Follow Me

A temperature sensor built-in the Remote Controller will sense its surrounding temperature. The unit will adjust the room temperature more accurately to give you comfort.

### High Ambient Cooling

The indoor space can be cooled to a desired, comfortable indoor temperature, even when outside temperatures reach up to 122° F.

### High Heating Operation

The High Tier and Mid-Tier systems can be a primary heat source, with high Heating down to -22° F, so when it's cold outside, it's warm inside.

### Independent Vane Control

Air flow direction from individual outlets can be controlled separately to achieve the optimal air flow based on a room's configuration.

### Inverter Technology

With the Inverter, the outdoor unit uses only the energy required to meet the desired temperature requirements of the indoor unit, thus lowering electric bills.

### Louver Position Memory

A horizontal louver will automatically move to the same position that was set the last time the unit was on.

### Low Ambient Cooling

Even when it's cold outside, but warm inside, the air conditioner will keep the area cool — perfect for server rooms and commercial kitchens.

### Refrigerant Leak Detection

The indoor unit shows error code "EC" and stops automatically when refrigerant leakage is detected. This protects the compressor from high temperature damage due to refrigerant leakage.

### Single and Multi-Zone Compatible

A single zone outdoor unit can be paired with any indoor unit type. One multi-zone unit can be leveraged for up to five indoor units of any style.

### Sleep Mode

This function enables the system to automatically increase cooling or decrease heating by around four degrees for the first two hours, then holds steady for the next five hours. After that, it will switch off. This function achieves both energy savings and comfort at night.

### Stepless Frequency Adjustment

Precise control maintains a stable and constant room temperature while reducing the sound level and saving energy.

### Two-Way Draining

Connections, piping and drainage can be installed from both the left and right on the high wall.

### Universal Matching

Get maximum flexibility with up to five different indoor units connected to one outdoor unit. Maintain a different temperature in each room for ultimate comfort, with the best indoor unit choice for each. Universal matching units are also available for single zone outdoor units. One outdoor unit can match any type of indoor unit.

### Wired Remote Controller

Compared to an infrared remote controller, a Wired Controller can be fixed on the wall and makes air conditioner operation more convenient for larger setups or Ducted units.







**Heil-HVAC.com**

---

**HEIL**  
PO Box 128  
Lewisburg, TN 37091

©2022 Carrier. All Rights Reserved. Midea is a registered trademark owned by Midea Group Co., Ltd.  
Wi-Fi® is a registered trademark of Wi-Fi Alliance.  
ENERGY STAR® is a registered trademark of the U.S. EPA.

All trademarks and service marks referred herein are property of their respective owners.

Part No. DLS-001-HL-00  
May 2022



*A Proud Member of the Carrier Family*  
©2022 Carrier. All Rights Reserved.

